

BUY IN PRINT **WORLDWIDE** [MAGPI.CC/STORE](https://magpi.cc/store)

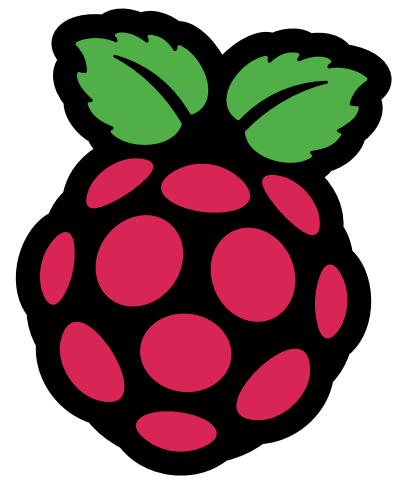

# The *MagPi*



Issue 123 | November 2022 | [magpi.cc](https://magpi.cc)

The official Raspberry Pi magazine

**BUILD A**

# SMART HOME

- + Automated Lights
- + Smart Garage Doors
- + Home Assistants



**UPCYCLE AN AMSTRAD INTO A CYBERDECK**



**BUILD A PICO Game Boy**



**CONTROL A 3D PRINTER WITH BMO**



CONTROL YOUR **CHRISTMAS LIGHTS** WITH PICO W



# Industrial Raspberry Pi

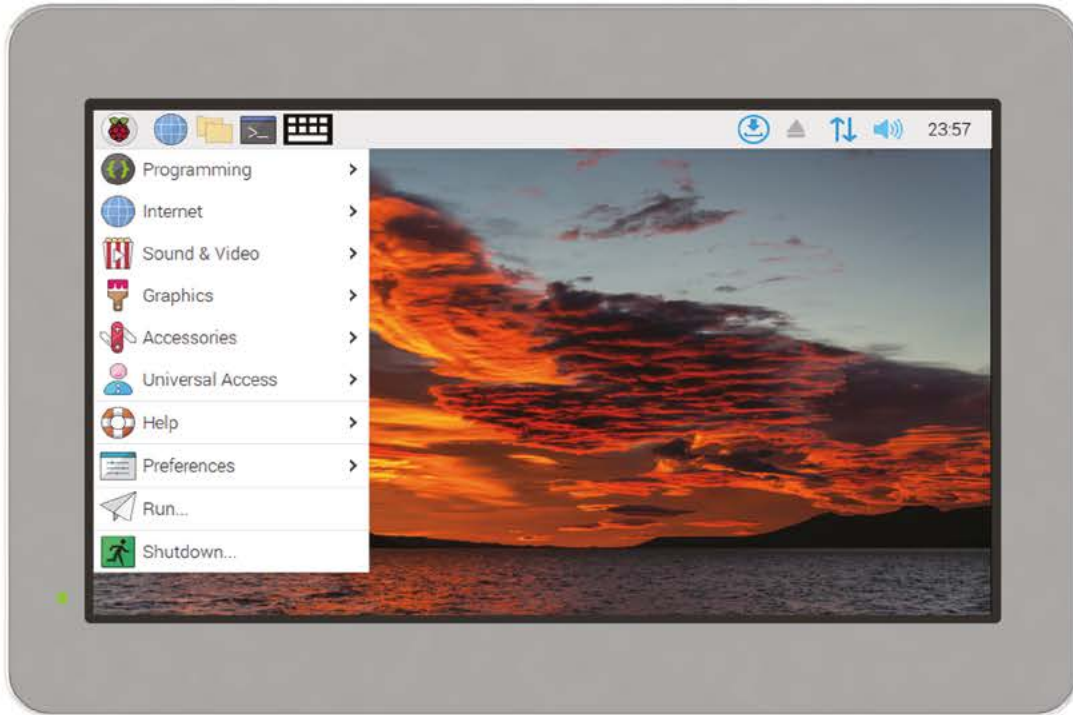

## ComfilePi

The ComfilePi is a touch panel PC designed with high-tolerant components and no moving parts for industrial applications. It features a water-resistant front panel, touchscreen, color LCD (available in various sizes), RS-232, RS-485, Ethernet, USB, I2C, SPI, digital IO, battery-backed RTC (real-time clock), and piezo buzzer.

Use the rear-panel 40-pin GPIO header to expand its features and capabilities with additional I/O boards. The ComfilePi is UL Listed and employs Raspberry Pi Compute Module.

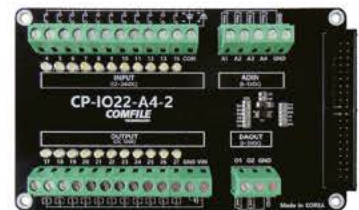

# WELCOME

## to *The MagPi* 123

**M**ost makers have an inner Wallace and Gromit: inner fools armed with a spanner and some string that are ready to wire up an alarm clock that cooks breakfast.

This month, we're looking at wiring up your house with Raspberry Pi Pico W to build your own smart home (page 40). The small footprint and low power demand of Pico W, combined with its wireless LAN capabilities, make it ideal for dotting around the house to turn on and off gadgets. Consequently, a wide range of home automation kits and project ideas have sprung up, and we thought it high time to see what is possible. So, if you fancy smart-lighting, face-tracking cameras, burglar alarms, and automated doors, this issue is for you.

Lucy Hattersley Editor



**EDITOR** Lucy Hattersley

Lucy is editor of *The MagPi* and loves her house. Still bashing it into shape, but at least it now has floors. Smarts to come.

[magpi.cc](http://magpi.cc)

GET A  
**RASPBERRY PI  
PICO W**  
WITH A SUBSCRIPTION!  
**PAGE 34**



# MicroPi Starter Kit

## IoT Hat & Raspberry Pi 3A+



Programming  
(Python)



Open Source



Online  
Courses



Linux OS  
(Raspberry Pi OS)



Robotics



Home  
Automation



Artificial  
Intelligence



Internet of  
Things (IoT)

## Raspberry Pi (Reimagined)

A Windows 10 laptop is recommended for use with the MicroPi.



<https://micropi.org>



*Entaniya*

## All-Weather Case for Raspberry Pi Camera Module 2

Fitting the Raspberry Pi Camera Module 2 and SPRESENSE Camera Board (CXD5602PWBCAM1), the Entaniya All-Weather Case is a durable case suitable for applications such as surveillance cameras, industrial cameras, VR, AI, and robotics. It is made of ASA resin, which is highly light and weather resistant.



[products.entaniya.co.jp/en/](https://products.entaniya.co.jp/en/)

Complete kit with tools for fast assembly



Mount bracket available optionally



Suitable for super-wide capturing with the Entaniya VR 220 Camera



For inquiries, please contact [products@entaniya.co.jp](mailto:products@entaniya.co.jp)

Entaniya Co.,Ltd., Nishiwaseda 2-5-13, Shinjuku-Ku, Tokyo 169-0051, Japan | [www.entaniya.co.jp](http://www.entaniya.co.jp)

# Contents

► Issue 123 ► November 2022

## Cover Feature

**40** Build a Smart Home

## Regulars

- 36** Case Study: ECO Parking
- 92** Your Letters
- 97** Next Month
- 98** The Final Word

## Project Showcases

- 08** PoleFX
- 12** NB100 Cyberdeck
- 14** Cyberdog Smart Saddle
- 18** PicoStepSeq
- 20** Arribada Penguin Monitoring
- 24** KeezyBoost40
- 26** Tiny System Monitor
- 28** BMOctoprint
- 32** Raspberry Pi Beret

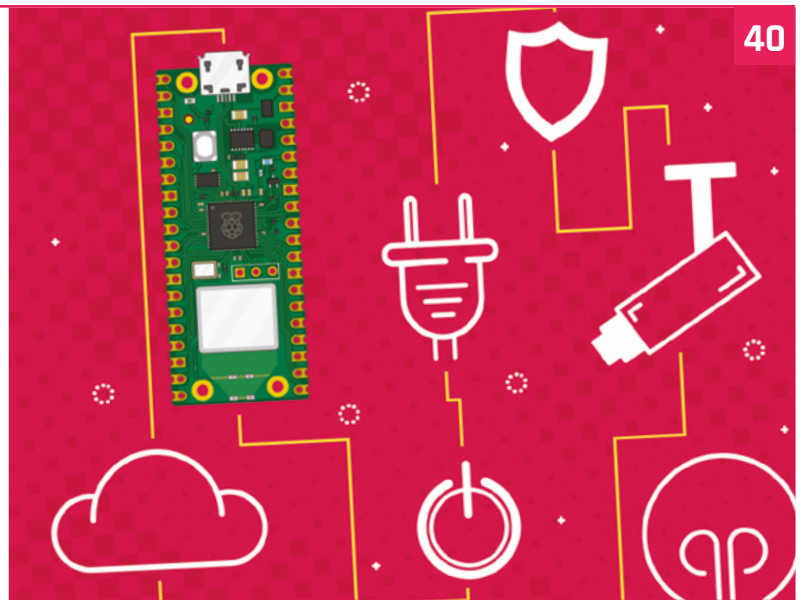

40



20

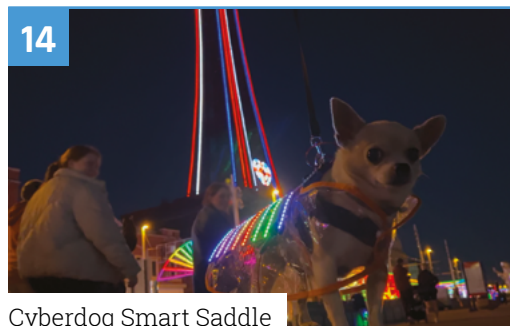

14

Cyberdog Smart Saddle

Arribada Penguins

The MagPi magazine is published monthly by Raspberry Pi Ltd. Publishers Service Associates, 2406 Reach Road, Williamsport, PA, 17701, is the mailing agent for copies distributed in the US. Application to mail at Periodicals prices is pending at Williamsport, PA. POSTMASTER: Send address changes to The MagPi magazine c/o Publishers Service Associates, 2406 Reach Road, Williamsport, PA, 17701.

Tutorials

- 50 Build a MicroPython handheld
- 56 Pico W IoT - weather dashboard
- 62 Getting hands-on with relays

The Big Feature

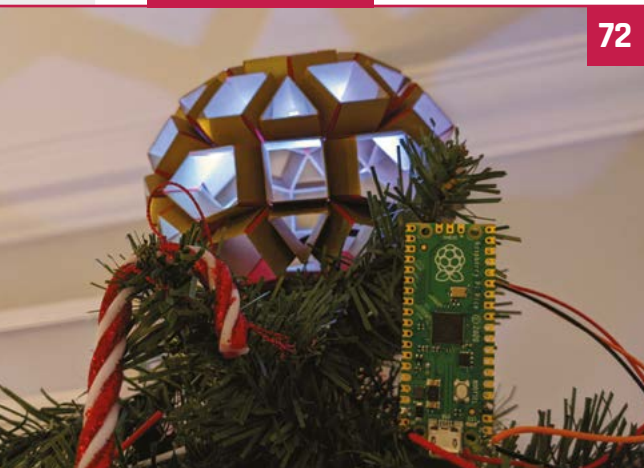

72

Pico-powered Christmas tree lights



50

Build a MicroPython handheld

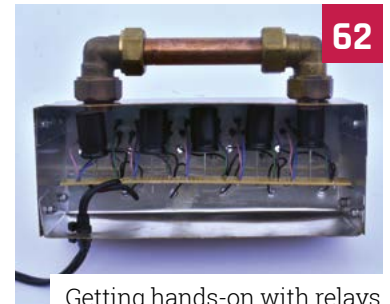

62

Getting hands-on with relays

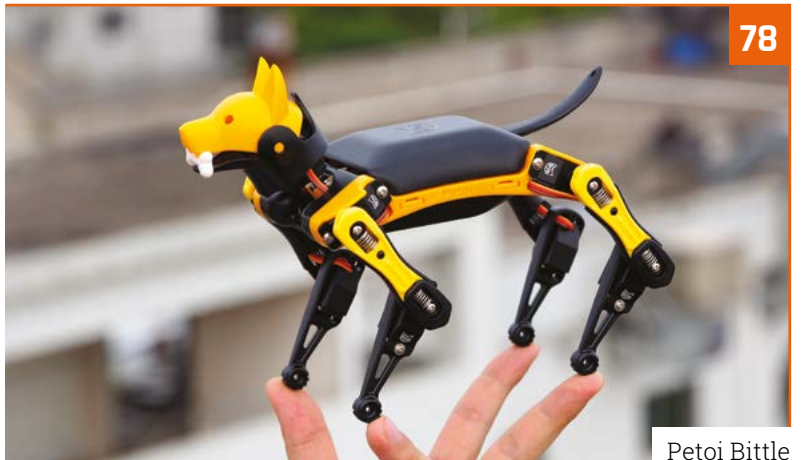

78

Petoi Bittle

Reviews

- 78 Petoi Bittle
- 80 MicroPi Starter Kit
- 82 Top 10 Pico accessories
- 84 Learn Raspberry Pi OS

Community

- 86 Sophy Wong interview
- 88 This Month in Raspberry Pi



84

Sophy Wong interview

**WIN**  
1 OF 5  
**TUFTY**  
**2040s**



95

**DISCLAIMER:** Some of the tools and techniques shown in The MagPi magazine are dangerous unless used with skill, experience, and appropriate personal protection equipment. While we attempt to guide the reader, ultimately you are responsible for your own safety and understanding the limits of yourself and your equipment. Children should be supervised. Raspberry Pi Ltd does not accept responsibility for any injuries, damage to equipment, or costs incurred from projects, tutorials or suggestions in The MagPi magazine. Laws and regulations covering many of the topics in The MagPi magazine are different between countries, and are always subject to change. You are responsible for understanding the requirements in your jurisdiction and ensuring that you comply with them. Some manufacturers place limits on the use of their hardware which some projects or suggestions in The MagPi magazine may go beyond. It is your responsibility to understand the manufacturer's limits.

# SELECTION STARTS HERE



With over 2,300 name-brand, industry-leading suppliers—be confident we've got your electronic component and automation needs covered.

Find it at [digikey.co.uk](https://www.digikey.co.uk) today, or call 0800 587 0991.



Digi-Key is a franchised distributor for all supplier partners. New products added daily. Digi-Key and Digi-Key Electronics are registered trademarks of Digi-Key Electronics in the U.S. and other countries. © 2022 Digi-Key Electronics, 701 Brooks Ave. South, Thief River Falls, MN 56701, USA

ECIA MEMBER  
Supporting The Authorized Channel

# PoleFX

The networking power of Raspberry Pi drives LED lights to liven up acrobatic dance routines. **Lucy Hattersley** gives PoleFX a twirl



**Spencer Hochberg**

Spencer spent his teenage years inventing unicycle tricks with photography and videography as a side effect. He earned a degree in mechanical engineering from UCLA, and now works with small teams on live shows.

[polefx.com](http://polefx.com)

**B**illing itself as the world's most advanced dance pole, PoleFX uses thousands of LED lights embedded inside a network-connected pole. On the sidelines, a Raspberry Pi-powered network box is using OpenCV to image match videos and turn them into light-based visual animations.

"Our goal is to create functional pieces of art and embed show technology into new places," explains Spencer Hochberg, inventor and owner of PoleFX.

Amongst the dazzle and display, it is easy to overlook the technical requirements of this build. The pole itself needs to be "structurally strong" explains Spencer, to withstand the dynamic moves of acrobats, "while protecting and displaying an array of thousands of integrated pixels."

Those thousands of pixels create an LED screen inside the pole structure. "The pole acts as a canvas for digital art that complements the performer," explains Spencer.

## Networked light

Inside PoleFX sits a Raspberry Pi acting as the system's content server and control interface. Each pole is connected to PoleFX via an Ethernet cable, and the poles receive frames of data "on-the-fly" from Raspberry Pi.

The control surface is a local web interface. "We also support simple control using a USB keyboard, encoder with OLED display, as well as DMX [Digital Multiplex lighting controller]," Spencer tells us.

"Raspberry Pi made it easy for us to put a flexible, low-cost brain in the middle of our system. The giant community of users has made it easy to find tutorials to get started and configure everything," he notes.

The low power requirements for Raspberry Pi were also a consideration, and the "huge amount of online resources" made it quick and painless to implement.

The current poles are powered using a Raspberry Pi 3 Model B, which is processing and sending frames out at 60 fps.

## Pole design

The poles had to be specially designed and custom-built for purpose. The outer shell of the pole is made using "extruded black polycarbonate tubes." Spencer tells us this material is "resistant to cracking and hides the LEDs." They allow the light to shine through.

Inside the pole, 3D-printed parts are used to mount non-structural components, and an internal slip ring that enables the wire connections to spin as the pole rotates.

PoleFX is "mostly built from off the shelf components." The main mounting plate inside is a custom PCB (printed circuit board), which is an "easy way to fabricate a mounting plate and simplifies the internal wiring." The back panel of the enclosure where the ports are exposed is also a PCB, used only for mechanical and cosmetic qualities.

## Smart software

The main code is written in Python and the patterns are encoded as H.264 video files. The video frames are read using OpenCV to sample the pixel values. "We then composite and make other post-processing adjustments before sending the pixel data out over the Ethernet network in multicast sACN/E1.31 packets," Spencer reveals.



The outer shell of the pole is made using extruded black polycarbonate tubes that allow light to shine through

Inside the pole are thousands of LED lights with the pattern determined by OpenCV scanning a video file

An internal slip ring enables the wire connections to spin as the pole rotates

### Quick FACTS

- ▶ One of Spencer's first projects was an LED unicycle wheel
- ▶ Spencer designed the first LED pole prototype six years ago
- ▶ It started as a collaboration with performance company SpinFX
- ▶ The free-standing and aerial poles cost just \$100
- ▶ The poles are approved for a maximum weight of 330 lbs (150 kg)



▲ The PoleFX box contains a Raspberry Pi and the ESP32 board, and connects to the poles via Ethernet cables



▶ The animated poles enable the dance to have an extra layer of expression while the dancers perform their routines

◀ The poles need to be structurally strong to withstand the acrobatic moves while protecting/displaying the array of thousands of LEDs

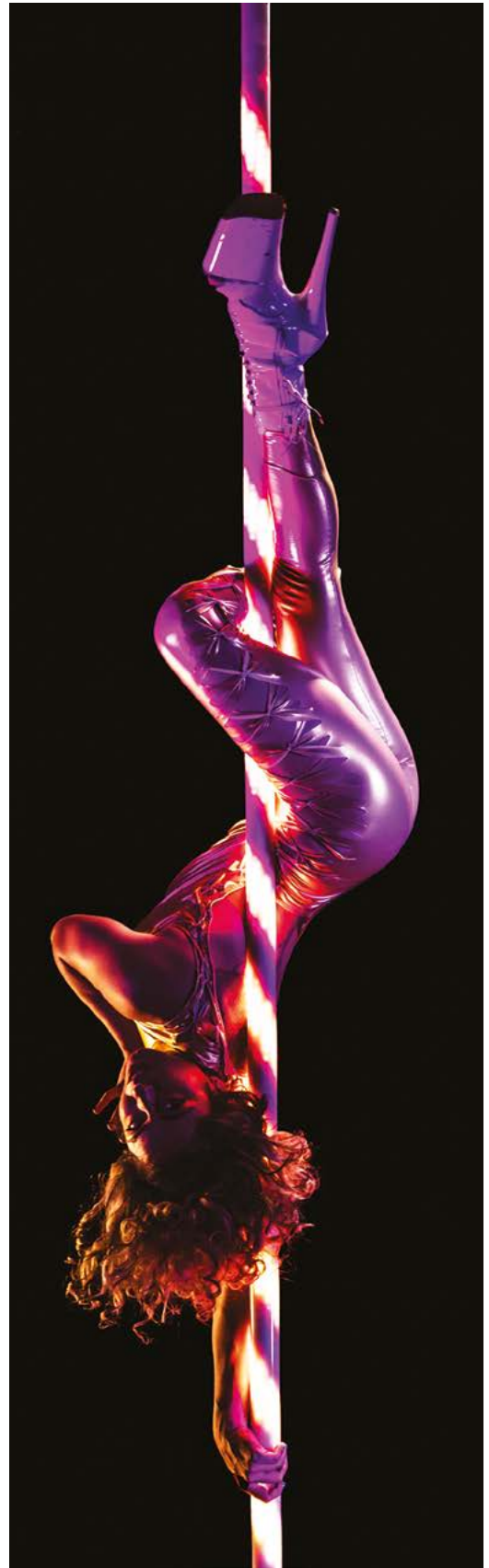



Raspberry Pi is configured as a wireless LAN hotspot that hosts an Open Stage Control server, so the user can connect to the network and load the control UI without having to install anything.

Apart from controlling dance poles, the content-server side of the project is generally useful for storing, generating, and playing back

▲ The pattern is created by scanning video files with image recognition software

“ Touch-reactive LED handrails and jungle gyms may be just around the corner ”

LED animations for a wide range of installations where a whole PC would be “overkill”, and “a microcontroller alone is too limited.”

An early motivation for building load-bearing, pixel-mapped poles was to then use them to build larger structures. “Touch-reactive LED handrails and jungle gyms may be just around the corner!”

## How PoleFX works



**01** Inside the PoleFX box is a custom ESP32-based board with an Ethernet interface. Each pole is connected to the board via an Ethernet cable which transmits the data to the LEDs.

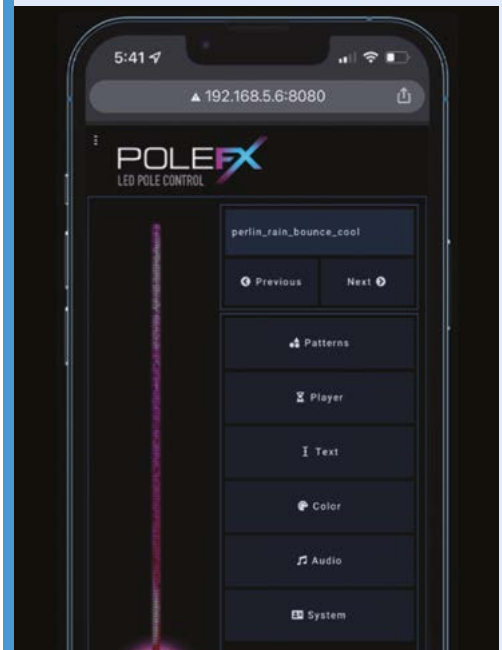

**02** A local web interface is used to select different patterns and add text to the pole design.



**03** The pattern on the pole is created using OpenCV to pattern-match a H.264 video stream (which is converted to a matching LED display).

# NB100 Cyberdeck

Philipp Hoeler-Lutz has torn an Amstrad NC100 Notepad apart and turned it into a cyberdeck Linux terminal using a Raspberry Pi computer, as **David Crookes** discovers



MAKER

**Philipp Hoeler-Lutz**

Philipp is a NixOS nerd who likes to build mechanical keyboards and small devices with a taste of cyber.

[nerdbude.com](http://nerdbude.com)

▼ How it began: the Amstrad NC100 before Philipp ripped it apart. He says the machine wasn't working and wasn't in the best condition

**A**s self-confessed retro nuts, we did a double take when we saw the Clockwork Pi DevTerm ([magpi.cc/devterm](http://magpi.cc/devterm)). It reminded us of the TRS-80 Model 100 portable computer while also showing how attractive a notepad device can be nearly 40 years on, with a full physical keyboard beneath a widescreen display.

What's more, we're not alone in thinking this. "When I saw the DevTerm, I thought – wow – I need this!", says Philipp Hoeler-Lutz. And yet the price put him off, prompting a search for a different way of achieving the same result.

"I found an affordable Amstrad NC100 and I thought this was the form factor I wanted at an affordable price," he says. "It also looked similar to the cyberdeck I imagined when reading William Gibson's *Neuromancer* novel. It didn't take long to find a purpose."

## Sugar coating

The Amstrad NC100 was an A4 slimline notepad 8-bit computer which used the Z80 processor and came with a built-in LCD screen that displayed

80 characters columns across eight rows. It had 64kB of RAM, 256kB of ROM, and a full keyboard with a handful of coloured keys. The Protex text processor was built-in alongside other 'office' apps. But Philipp wasn't impressed.

"I removed all the parts," he says. "For me, the NC100's processor power, ROM, and RAM are insufficient for today's use and the monochrome display is small. I also found the keyboard was pretty awful if you're used to mechanical keyboards." Yet he liked the overall design: "It looks cool. I thought I'd give it a new, modern life."

Retaining only the case, he based his project around a Raspberry Pi computer. He decided he'd replace the screen with an 8.8-inch 1920x980 widescreen LCD, and use a CRKBD driven by an Arduino Pro Micro board.

"A friend, Alejandro, sent me some CRKBD PCBs and I was blown away," Philipp says. "It's a small, split keyboard with three rows of six keys per side. When I tested the two halves, they fit almost perfectly, especially given that the height of the CRKBD is quite low. That said, I still had to move the keyboard microcontroller away from the PCB and pack it under the display."

You can find out more about the CRKBD (aka Corne Keyboard) at [magpi.cc/crkbd](http://magpi.cc/crkbd).

## A fitting end

Space was a major issue. "There's only about 9x29x2 cm available to put Raspberry Pi, the cables, and display including the control board inside," Philipp explains. He decided to put the display on top of the case rather than recess it, saving 4 mm. He also removed the Amstrad's battery compartment and sanded away all elevations. Once done, it was a matter of connecting everything up and using the operating system NixOS.

"NixOS is different from other Linux distros," he notes. "It's declarative and very easy to produce with the entire OS configurable in a single config file. You can also generate your own development



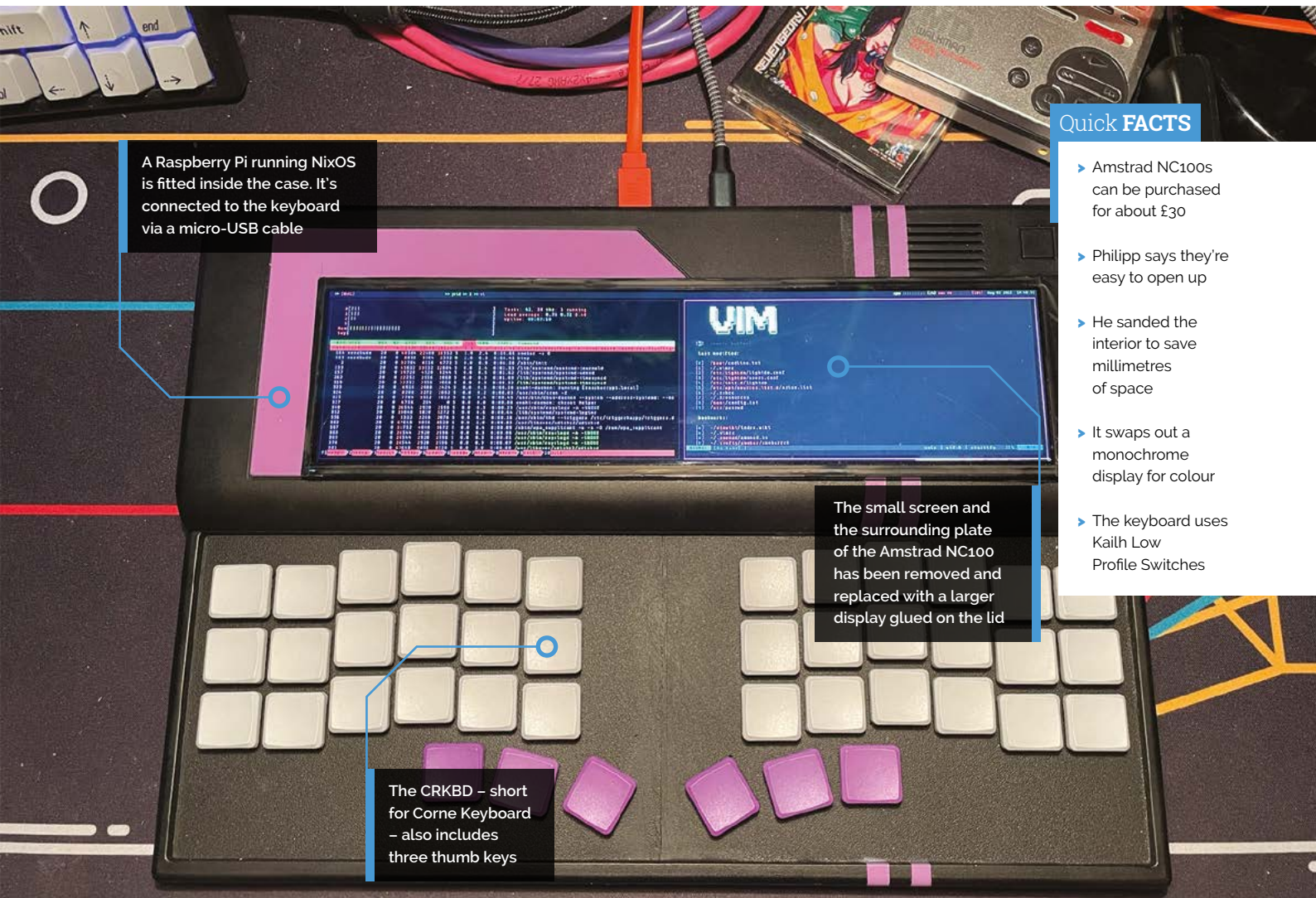

A Raspberry Pi running NixOS is fitted inside the case. It's connected to the keyboard via a micro-USB cable

The small screen and the surrounding plate of the Amstrad NC100 has been removed and replaced with a larger display glued on the lid

The CRKBD – short for Corne Keyboard – also includes three thumb keys

#### Quick FACTS

- ▶ Amstrad NC100s can be purchased for about £30
- ▶ Philipp says they're easy to open up
- ▶ He sanded the interior to save millimetres of space
- ▶ It swaps out a monochrome display for colour
- ▶ The keyboard uses Kailh Low Profile Switches

“For me, the NC100's processor power, ROM, and RAM are insufficient for today's use”

environment in NixOS, including the dependencies for each project. I can briefly test tools without installing them too.”

The result of all of this hard work is a cyberdeck that works as a Linux terminal, allowing Philipp to run a Mastodon social networking service, use the text editor Vim, blog, and enjoy RSS among lots of other things. “Using the NB100 means I don't have to sit down at my laptop or computer,” he says. “And I'm still able to use this beautiful piece of Amstrad hardware.”



# Cyberdog Smart Saddle

Smart pups sport luminous collars, but true fashionistas shimmer in NeoPixels, courtesy of Raspberry Pi. **Rosie Hattersley** reports from the canine catwalk



**Kevin McAleer**

Kevin makes robots, brings them to life with code, and makes videos about them on YouTube.

[magpi.cc/kevsrobots](http://magpi.cc/kevsrobots)

**W**ith the change of seasons, self-confessed “Raspberry Pi nerd” Kevin McAleer figured his beloved pups could do with some eye-catching outerwear to ensure they’d be seen during their evening walk. After a quick consultation with his chihuahua, Archie, about his modelling fees, Kevin set about designing the NeoPixel-encrusted Cyberdog Smart Saddle, an RGB LED coat that Kevin would be able to control from his phone.

## Brighter, later

Kevin McAleer’s work may be familiar: he hosts a popular Sunday YouTube robot design channel ([magpi.cc/kevsrobots](http://magpi.cc/kevsrobots)). Among other intriguing makes, we’ve recently featured

both Kevin’s Billy Bass remotely flappable fish ([magpi.cc/billybass](http://magpi.cc/billybass)) and his PIKON DIY camera ([magpi.cc/pikoncamera](http://magpi.cc/pikoncamera)). While both those projects upcycle existing hardware, the idea behind the delightful doggie Day-Glo jacket was “to create something fun from some foot-long LED NeoPixel strips.” Kevin realised that he could control these from a couple of feet away using a Pimoroni Plasma 2040 microcontroller.

The Plasma 2040 also has a very important current-limiting function that ensures Archie doesn’t end up toasted, should the lights short out and draw a lot of current very quickly. However, the Plasma lacks both Bluetooth and wireless connectivity. This is where Raspberry Pi Pico W comes in. With the low cost of Pico Ws, Kevin



### Warning! Heat

Without being alarmist, strapping your pet into a jacket clad in electrical currents could cause discomfort if the circuit produces too much heat. Choose a power supply and controller with current limited to prevent overheating. Be sure to check the heat levels of the jacket before fitting.

[magpi.cc/currentlimiting](http://magpi.cc/currentlimiting)

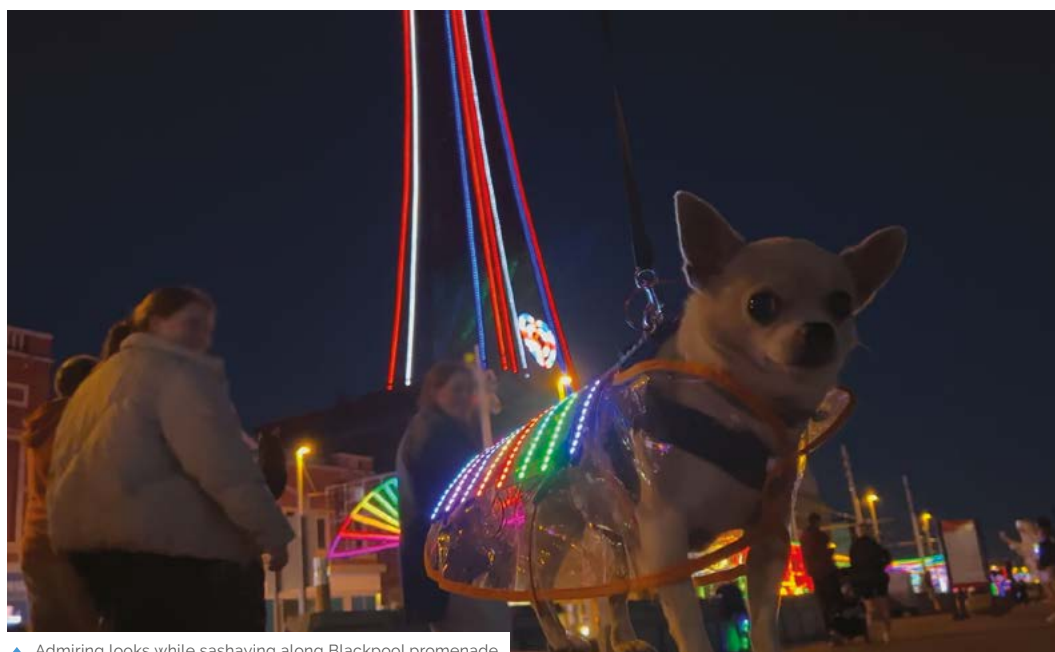

▲ Admiring looks while sashaying along Blackpool promenade



### Quick FACTS

- ▶ Assembly and testing took two evenings
- ▶ Two coats of superglue were needed..
- ▶ ..."in order to withstand a dog's rigorous shake"
- ▶ Kevin's parts list includes a £2 PVC dog coat..
- ▶ ...and a cute chihuahua: "Priceless!"

Where better to show off some fancy illuminations than Blackpool? The light show is controlled via smartphone, with Pico W providing connectivity

The 3D-printed saddle contains a tiny LiPo battery, Raspberry Pi Pico W, and Plasma 2040

A Pimoroni Plasma 2040 LED strip driver is specifically designed to power multiple NeoPixel lights, crucially without getting overly warm

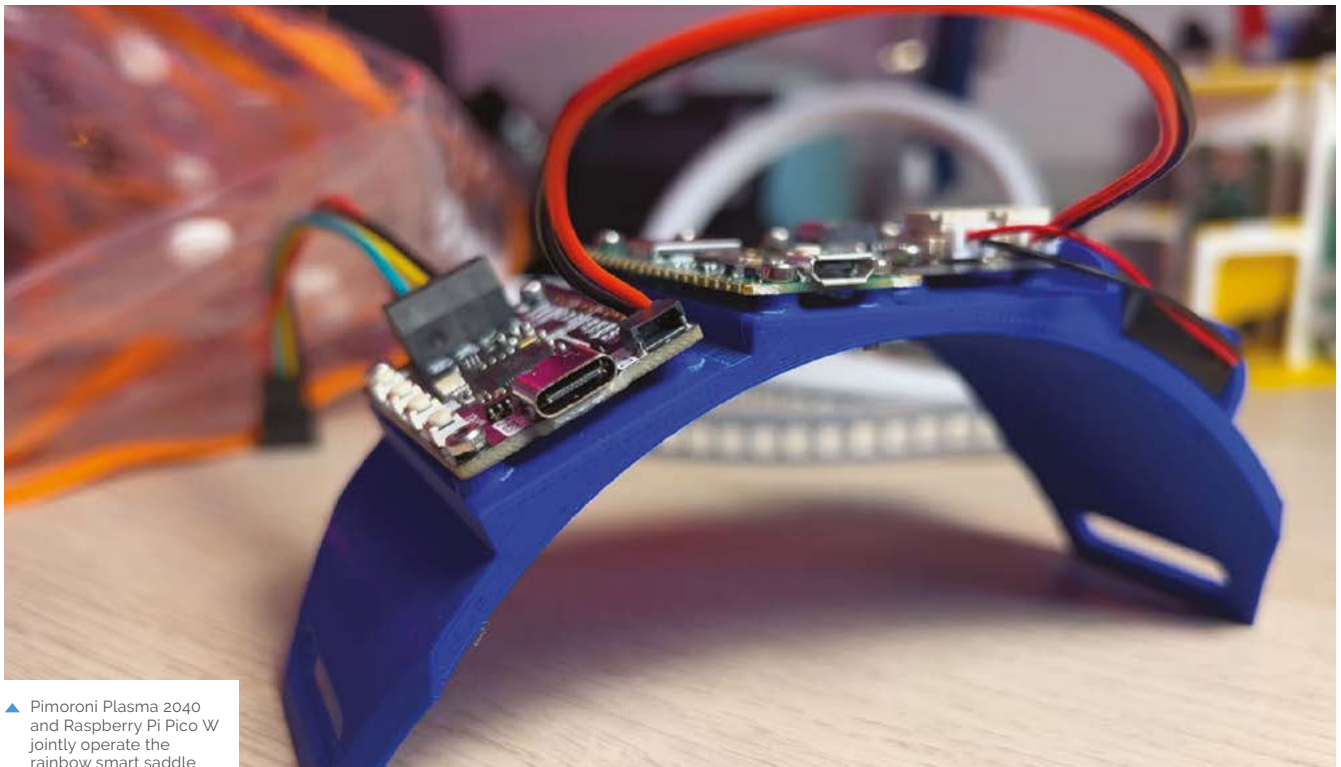

▲ Pimoroni Plasma 2040 and Raspberry Pi Pico W jointly operate the rainbow smart saddle

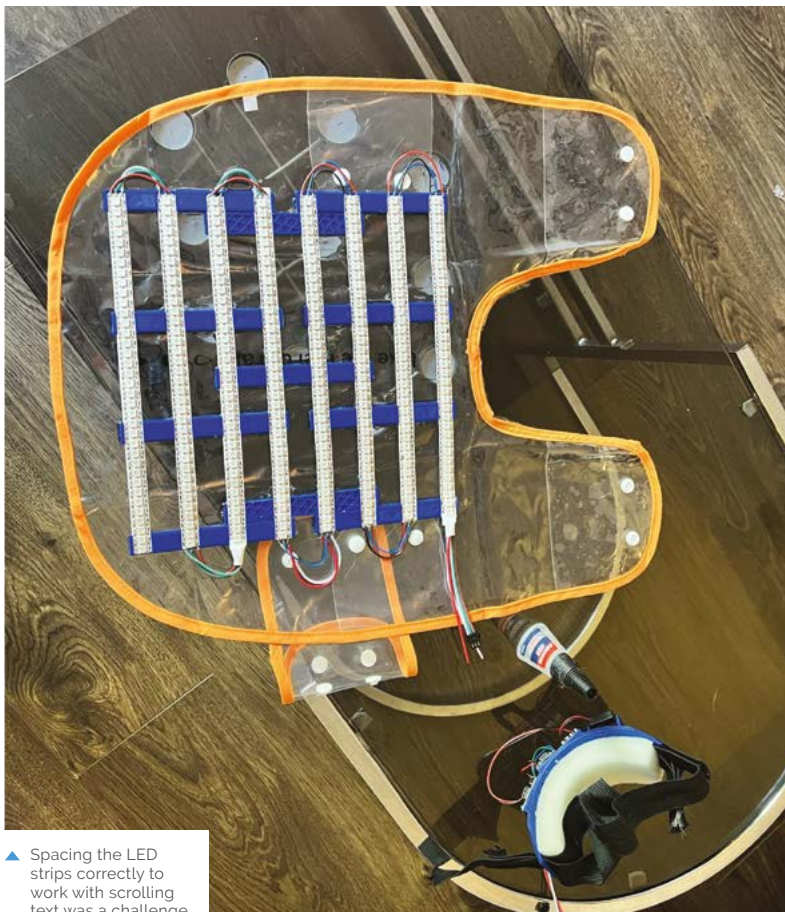

▲ Spacing the LED strips correctly to work with scrolling text was a challenge

thought, “well, why not just add one to the project and have it act as a bridge and front-end to the project? It can handle all the wireless stuff, whereas the Plasma 2040 can do what it’s best at – making LEDs light up.”

Kevin also had a cunning plan for powering everything: he’d run it all off a tiny LiPo battery, secreted in a self-contained harness that can comfortably sit on Archie’s back. Fingers crossed, the battery would last long enough for a stroll along Blackpool promenade, the home of illuminations and the perfect place to show off such a marvellously attired pup.

### Style and practicality

Designing the 3D-printed saddle was probably the biggest challenge, since it had to comfortably fit Archie while also holding all the electronics. “Will it fit right? Can it safely hold all the components? Will it be light enough?” were Kevin’s chief concerns here. He also worried whether the attention-grabbing effect would last long enough for a reasonable length stroll, and didn’t want Archie to have to style out a wardrobe malfunction. Adding a pocket to the saddle design to allow for speedy battery changes helped allay this fear, while applying lashings of superglue helped adhere the rainbow LED strips to the plastic dog coat.

Given his choice of microcontrollers, this is a MicroPython-based project, which suited Kevin very well. “I love MicroPython,” he declares. “All





the code [for the project] is written in this for simplicity and speed of creation. It's as close to English as any language I'm aware of; good code reads like regular sentences."

Kevin credits the "amazing" Phew! code from Pimoroni ([magpi.cc/phewgit](http://magpi.cc/phewgit)) for the easy setup

▲ Even single-colour LEDs attract attention, let alone Archie's full light show

## “ Designing the 3D-printed saddle was probably the biggest challenge ”

of wireless access point and web interface. Phew! (Pico HTTP Endpoint Wrangler) “does a couple of cool things,” Kevin explains. “It can make the Pico W into an access point for a device, meaning it will appear on your phone as a wireless hotspot.”

Another handy feature meant Kevin was able to add scrolling text as a final flourish to his already impressive illuminated Cyberdog Smart Saddle. Since Phew! can divert traffic to a specific web page, he was able to use it to change the LED patterns or scroll text he entered, and have it appear on the Cyberdog Smart Saddle. Cheeky!

“I'm not aware of any project that has influenced this,” says Kevin. “It's just a crazy idea I saw through to completion!” We think it's doggone good! [M](#)

## Brighten up!

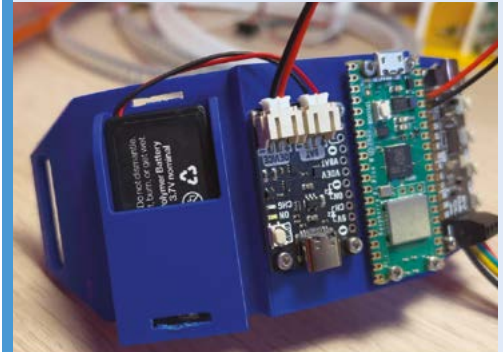

- 01** Use pencil and paper to measure up your pup for their Cyberdog saddle, taking their contours into account. Add a tiny pocket to your saddle design: it's ideal for keeping a LiPo battery that can be easily replaced.

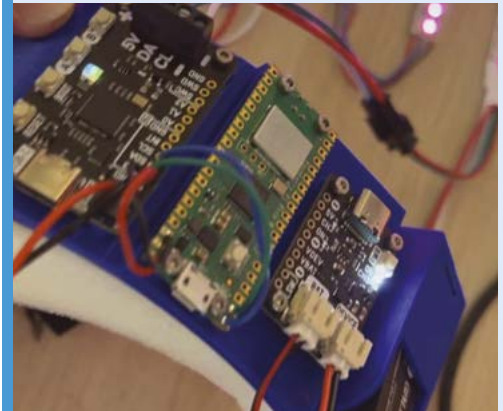

- 02** Connect the battery to connect to a Pimoroni LiPo Amigo Pro. This will charge it and can also connect to another device via a JST-PH connector. Kevin recommends Pimoroni's Phew! Code to add a wireless access point.

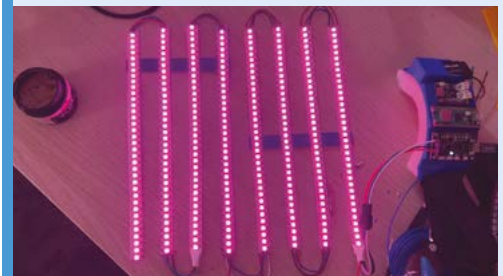

- 03** Check that the setup works and the lights illuminate as expected. 'Dog-proof' the LED strips by applying two or more lots of superglue, so there's less chance of them coming unstuck from the plastic dog coat.

# PicoStepSeq

Making music using code allowed MicroPython fan Tod to showcase RP2040's possibilities, as he explains to **Rosie Hattersley**



**Tod Kurt**

Tod has decades of experience as an embedded engineer, hardware hacker, Arduino guru and, latterly, a MicroPython/CircuitPython aficionado.

[todbot.com/blog](http://todbot.com/blog)

**E**mbedded systems and hardware hacking hold no fear for Tod Kurt, who has years of experience with both. Tod shares expert tips on Arduino and MicroPython ([magpi.cc/circuitpytricks](http://magpi.cc/circuitpytricks)), and recently unveiled this PicoStepSeq MIDI sequencer based on our favourite microcontroller board.

Prior to his adventures in Raspberry Pi Pico programming, Tod's company, ThingM, had launched a "simple but popular" USB LED notification light known as blink(1) ([blink1.thingm.com](http://blink1.thingm.com)). This provides a visual indication that you've received a message, email, retweet, and so on. The idea behind the PicoStepSeq is also visual: using GPIO pins, Tod planned to program Pico to light a series of LEDs at varying intensities when each note played. "The

Pico and the RP2040 are wonderful parts. So much possibility in such a small, inexpensive package!"

## Musical muse

Tod found easily available 'step switches' – lever switches with LEDs – as an inspiration. "I wanted to make a MIDI step sequencer, looking like the 1980s synths and drum machines that had these switches," he says. "Their integral LED makes it really clear of the state of the parameter that the switch is controlling, and they take up only a bit more space than a regular tactile switch. And their clicky-clicky sound is 'chef's-kiss'."

Tod was also keen to make a Raspberry Pi version of a four-button step switch project he'd read about on the Adafruit website: [magpi.cc/stepswitchparty](http://magpi.cc/stepswitchparty). "MIDI is a very forgiving protocol and much easier than trying to make an actual synthesizer", says Tod. He thinks step sequencers are "a good way to think about music creation, because it limits you to only eight notes and a small amount of time."

## Simple steps

Tod was keen to use both USB MIDI and serial MIDI, which meant he'd need some sort of display or user interface. Given the number of GPIOs he was going to need, the GPIO-laden Pico was an obvious choice and made project design a breeze. Every part – button, LED, display, encoder, and MIDI – is wired directly to the Pico without the need for GPIO expanders, key matrix, or 'charlieplexing', says Tod. (Assigning multiple functions to a button by giving them different responses if they are enabled, disabled, or partially enabled.)

Since Pico has PWM (pulse-width modulation) and movable UARTs, Tod could simply assign a command to any pin, as well as use variable brightness LEDs. Getting the timings right for the I2C displays was trickier: their 35 ms refresh rate is relatively sluggish compared to the rate of incoming MIDI messages.



▲ Tod experimented with case designs to achieve a 1980s retro effect

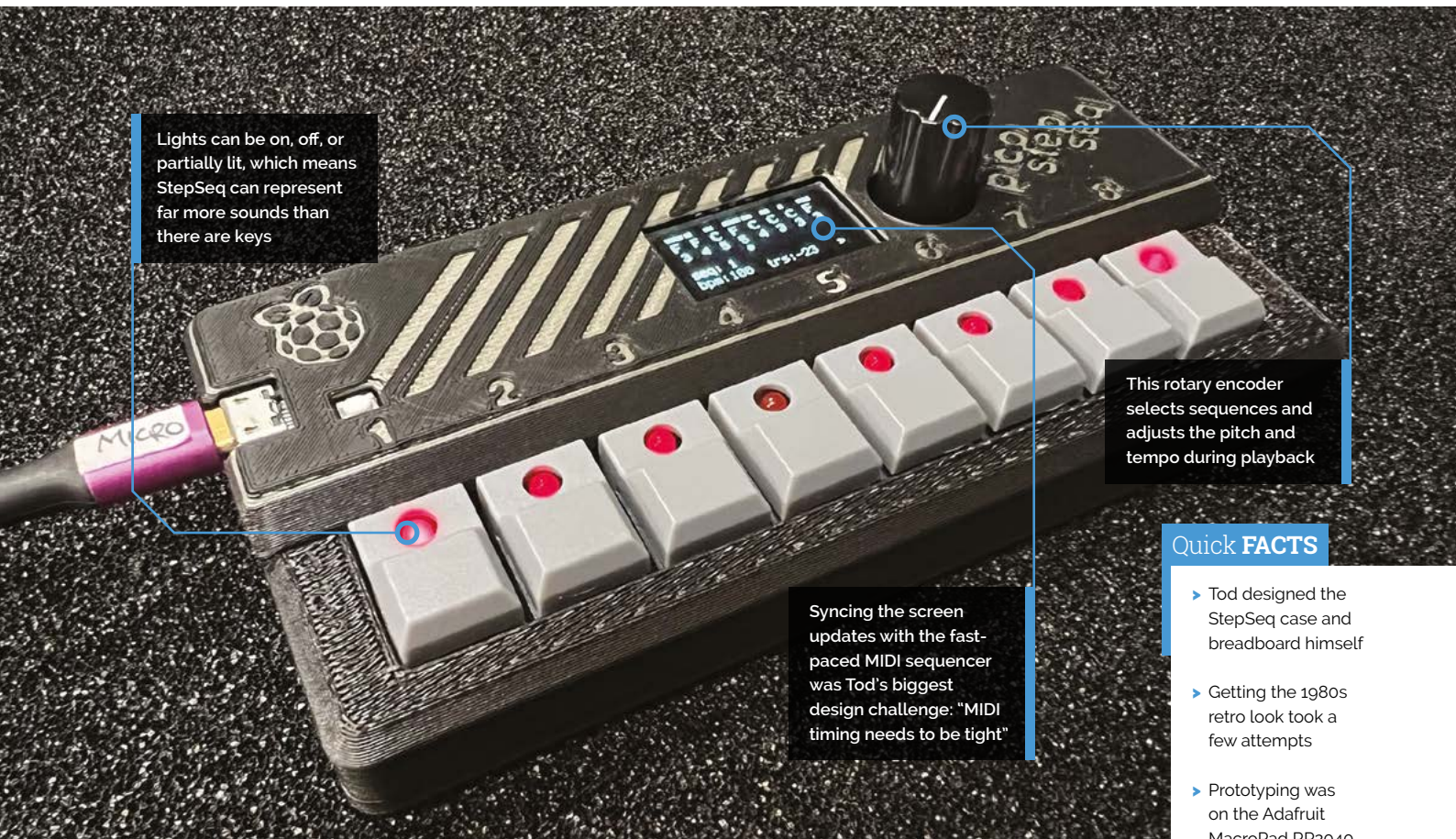

Lights can be on, off, or partially lit, which means StepSeq can represent far more sounds than there are keys

This rotary encoder selects sequences and adjusts the pitch and tempo during playback

Syncing the screen updates with the fast-paced MIDI sequencer was Tod's biggest design challenge: "MIDI timing needs to be tight"

### Quick FACTS

- ▶ Tod designed the StepSeq case and breadboard himself
- ▶ Getting the 1980s retro look took a few attempts
- ▶ Prototyping was on the Adafruit MacroPad RP2040, which has a similar I/O setup
- ▶ Tod created a MIDI drum 'brain' at uni, The Perc-a-lator
- ▶ More recent projects include a 22-key picotouch

Tod turned to CircuitPython for its displayio library, which sends only necessary messages over I2C. With this, "most display updates take 5-10 milliseconds, which means I can still send notes with relatively good timing," Tod explains. The code is on GitHub ([magpi.cc/stepseqgit](https://magpi.cc/stepseqgit)).

**“**The exact hardware can become a nifty tiny synthesizer **”**

Tod is already thinking of how to refine the StepSeq with "a MIDI arpeggiator that has a little bit of music theory built into it, so it always stays in the right musical key." The exact hardware can become a nifty tiny synthesizer too, he adds. "Perhaps the improved audio circuitry will be in PicoStepSeq Mk II." [M](#)

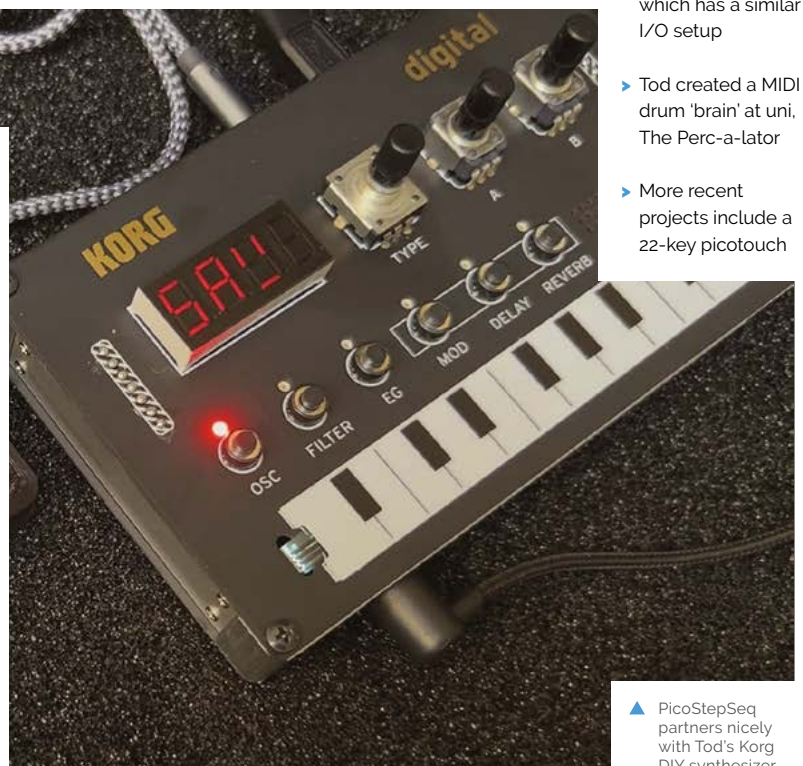

▲ PicoStepSeq partners nicely with Tod's Korg DIY synthesizer

# Arribada Penguin Monitoring

Getting closer to nature to understand creatures' lives is perhaps the perfect use of a Raspberry Pi and time-lapse camera pairing, thinks **Rosie Hattersley**



**Alasdair Davies**

Conservation scientist and NatureBytes co-founder Alasdair set up Arribada to provide low-cost, open-source wildlife monitoring hardware.

[arribada.org](http://arribada.org)

**C**ute creatures rule the internet and social media, which is absolutely as it should be. So it follows that photos of otherwise hard-to-encounter, impossibly personable penguins going about their daily business in the depths of an Antarctic winter, are likely to be pretty popular. The challenge, of course, is getting to the extreme south in the first place, and setting up a camera that can snap such shots and withstand temperatures as low as  $-30^{\circ}\text{C}$ . Arribada's Alasdair Davies decided he and his Raspberry Pi-based camera kit were up to the challenge of a long-term time-lapse photography project. Penguin Watch ([magpi.cc/penguinwatch](http://magpi.cc/penguinwatch)) takes and posts photos to a website, where citizen scientists avidly spot penguins. This enables the enterprise to monitor population numbers. What none of them could anticipate was the three-year gap between setting up the new cameras and being able to retrieve the resulting photos.

## Sea change scenario

Alasdair's wildlife monitoring and conservation work at The Zoological Society of London (ZSL) resulted in a Shuttleworth fellowship where he designed and built "anything from a special camera trap that would wake up and detect an

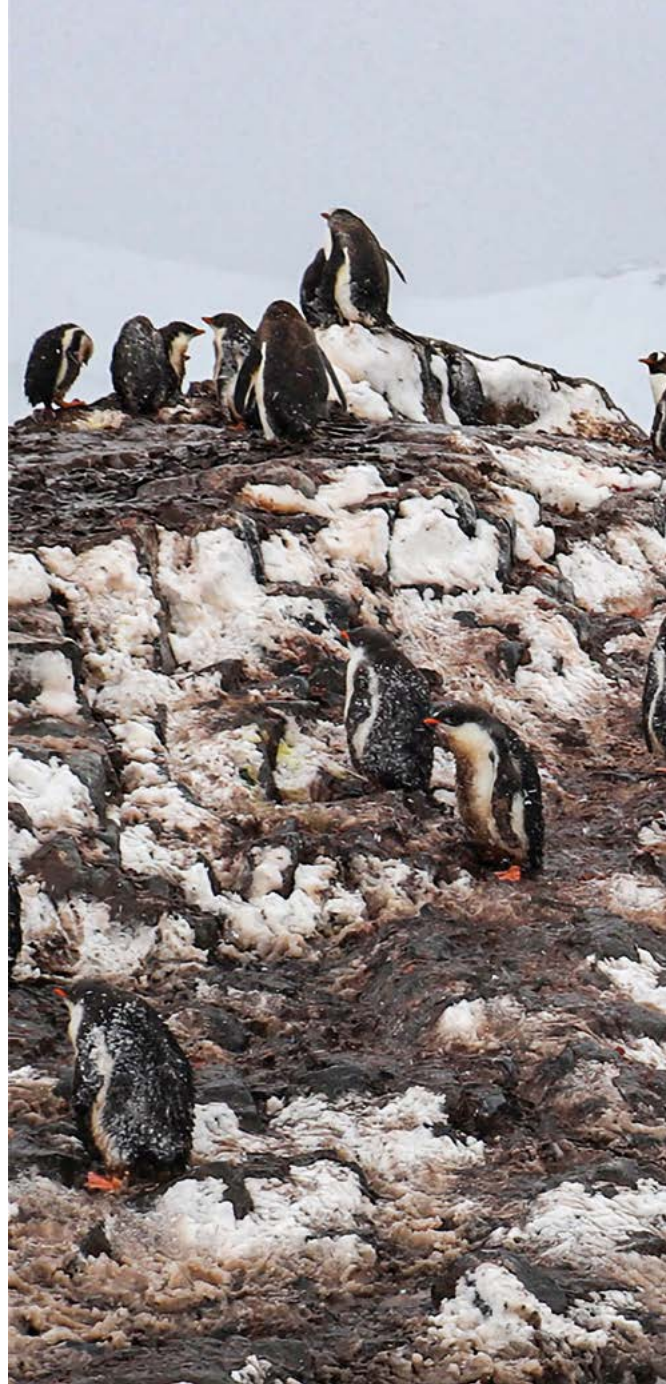

“ Their Raspberry Pi time-lapse camera setup had worked like a dream! ”

animal walking by, to a device that would send back an alert if a particular animal, such as an elephant, turned up.” Alasdair founded Arribada in 2017, and explains that his key aspiration was to get into open-source conservation technology so he could start to share some of the designs and make it more accessible for others to get involved.

He wanted to be able to put wildlife monitoring kits into the hands of young citizen scientists, have them interact with the live data and report back on changes over time. Surprise, surprise, Raspberry

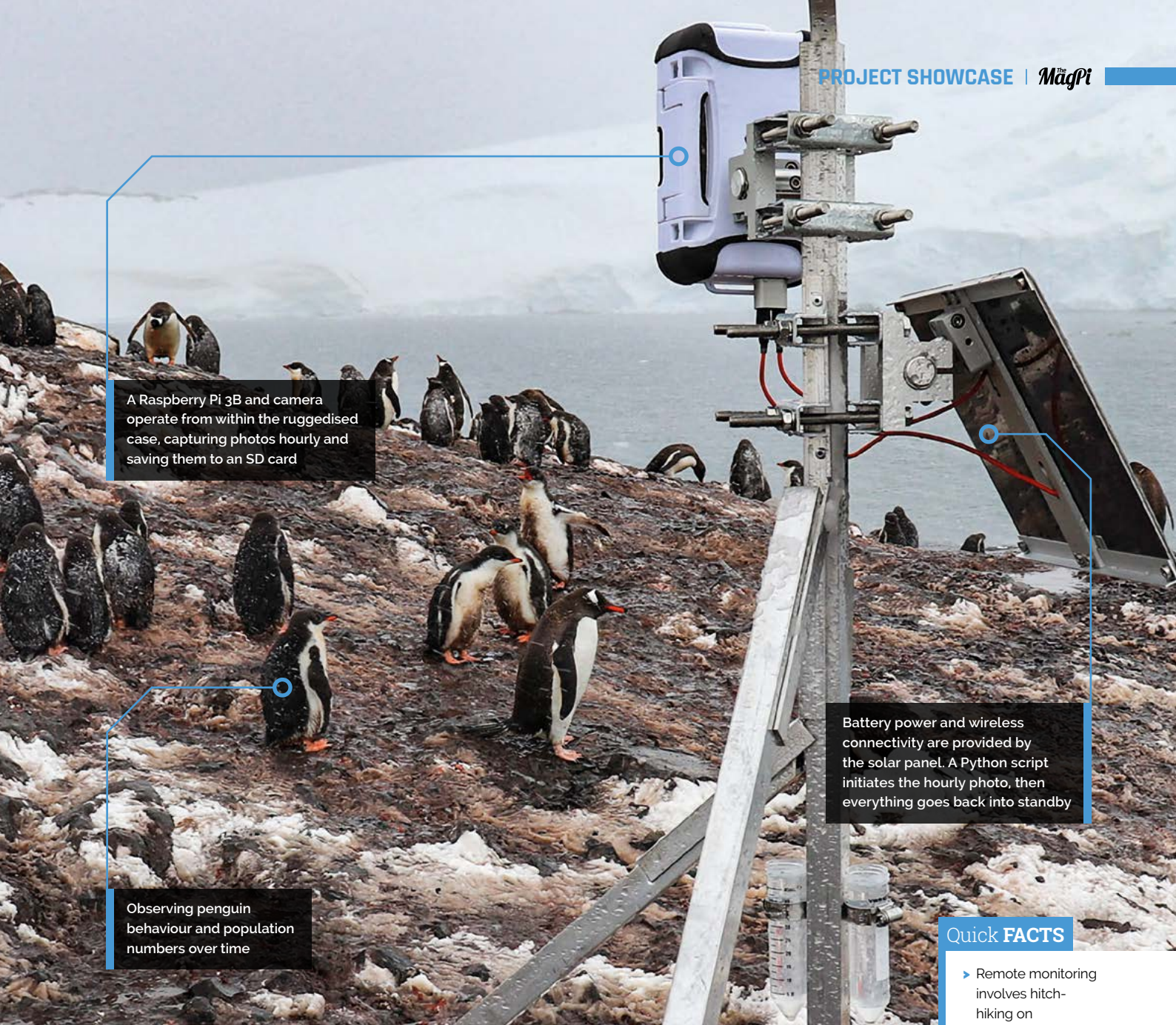

A Raspberry Pi 3B and camera operate from within the ruggedised case, capturing photos hourly and saving them to an SD card

Battery power and wireless connectivity are provided by the solar panel. A Python script initiates the hourly photo, then everything goes back into standby

Observing penguin behaviour and population numbers over time

**Quick FACTS**

- ▶ Remote monitoring involves hitch-hiking on research vessels...
- ▶ ...and dropping off/ retrieving time-lapse cameras as lifts allow
- ▶ Far too many time-lapse photos are generated each year
- ▶ But citizen scientists can help analyse them...
- ▶ ...by counting the penguins in each photo

◀ To preserve power, few photos are scheduled during the darker months, when penguins are, in any case, much less active





Pi loomed large in these plans. “Raspberry Pi had always been one of the tools I use because it was so accessible and affordable for anyone to get involved. And I was using it myself in a lot of the kind of products I was making at the time.” The name ‘arribada’ means arrival, and is specifically associated with the migration and birth cycles of sea turtles. In fact, one of Arribada’s earliest projects was creating a Raspberry Pi Zero-based device in a watertight shell that could be attached to a sea turtle and video its movements.

▼ In another Arribada project off Principe, a turtle equipped with a Raspberry Pi Zero-powered video camera on its back spies a friend



Creating a suitable device to monitor penguin populations in Antarctica involved an even more challenging environment. Soon enough, a penguinologist (yes, really!) from Penguin Watch got in touch about low-cost wildlife monitoring cameras that could provide evidence of long-term changes to its subjects’ behaviour and habitat, and form part of the conversation about climate policies. “They wanted to lower the cost of taking time-lapse photography of penguin colonies, watch the penguin colonies throughout the seasons, to understand if the penguin colony was affected by changes such as whether the lack of sea ice was causing more predation, and also whether it was delaying their nesting and feeding.” These are all questions you can answer if you have a camera and can point it at a colony, he points out.

Alasdair needed to come up with a camera setup resilient enough to withstand Antarctic winters and still deliver a regular stream of photos showing penguins’ everyday lives. Cost reduction was a huge factor: using Raspberry Pi Zero and a camera, along with a PiRA Zero power scheduling unit and solar panels, has cut costs by two-thirds to around £100, and is so energy-efficient that the setup can run for several years at a time.

The first time-lapse camera was programmed to wake up and take a photo once an hour every hour,



“ They wanted to lower the cost of taking time-lapse photography of penguin colonies ”

and was installed in February 2019 after hitching a lift on one of many “ships of opportunity” that visit Antarctica during its summer. There was no connectivity and no such opportunity to retrieve the camera from the peninsula, as planned the next year, due to the events of 2020. In 2021, “that particular day when the boat was going past our location, sea ice blocked entry so there was no way of getting to land and no chance of retrieving the camera,” Alasdair relates. The camera was finally retrieved in early 2022 when the team had the first chance to see whether their penguin monitoring had worked. Alasdair received the package in the post. “It stunk of penguin!” He placed the SD card into his computer: “it was just reading and reading for quite some time and suddenly stopped. And it said it discovered something like 32,764 items.” They’d got 32,000 photos of penguins and their habitat. Their Raspberry Pi time-lapse camera setup had worked like a dream! [M](#)

▲ Successive images taken from the same location show the changing habitat

## DIY critter watch



**01** Armed with a fresh installation of Raspberry Pi OS, a Pi HQ Camera, and a generous capacity SD card, follow the instructions at [magpi.cc/arribadamonitor](https://magpi.cc/arribadamonitor) to set up time-lapse photos. Their example is for photographing orchids.



**02** If the setup is to be used remotely, use a PiRA Zero ([irmas.eu/pira](https://irmas.eu/pira)) to schedule things, while a small solar panel might come in useful to ensure ongoing power.



**03** Most importantly, encase your hardware in a waterproof case and site your time-lapse camera out of harm’s way, perhaps securely lashed to a pole or tree, angled to where you know your critter often hangs out.

# Keezyboost40

If you've ever wanted to incorporate a screen into a keyboard, stay tuned. **Nicola King** discovers portable Pico perfection



**Christian Lo**

MAKER

Christian is a Canadian software engineer who develops and creates experimental mechanical keyboards in his free time.

[magpi.cc/sporewoh](http://magpi.cc/sporewoh)

Everyone needs a keyboard and the range available is ever-growing, but keyboard enthusiast **Christian Lo** decided to make his own portable version he could take with him on the go. The result is Keezyboost40, an ortholinear keyboard that also incorporates an LCD screen.

At the time, he didn't have the electrical engineering experience to design a circuit for an embedded microcontroller (like an RP2040), so instead opted to create a keyboard shield for Raspberry Pi Pico. The main issue was that there was no room to place Pico behind the keys.

"I then had the idea to hide the microcontroller behind an LCD as a way to reduce dead space, similar to the Ghoul keyboard ([magpi.cc/ghoul](http://magpi.cc/ghoul))," explains Christian. "That then spurred on ideas of all of the different possibilities [of what] I could do with such a keyboard now that it had something as expressive as an LCD."

## The fundamentals

The Keezyboost40 works by scanning through a key matrix. "Since the keyboard has 40 keys, I had to assign ten pins to the columns of the matrix, and four pins to the rows," notes Christian. "The keyboard effectively sends a signal to each of the columns one by one, and listens on the row pins for said signal." If the keyboard can hear something, then it knows that a key has been pressed; "Pico does all of that quite nicely."

He chose Pico for his project as it has ample pins, "which allowed me to easily have a key matrix and an LCD [connected via SPI] without any additional hardware required." Pico's castellated pins are also crucial in keeping the keyboard as low-profile as possible. "Pico was actually the near absolute perfect microcontroller for this project."

Christian designed his own PCB for the keyboard (via [pcbway.com](http://pcbway.com)). While he'd had some experience

▼ All the parts for the project, including Christian's custom-designed keyboard shield PCB

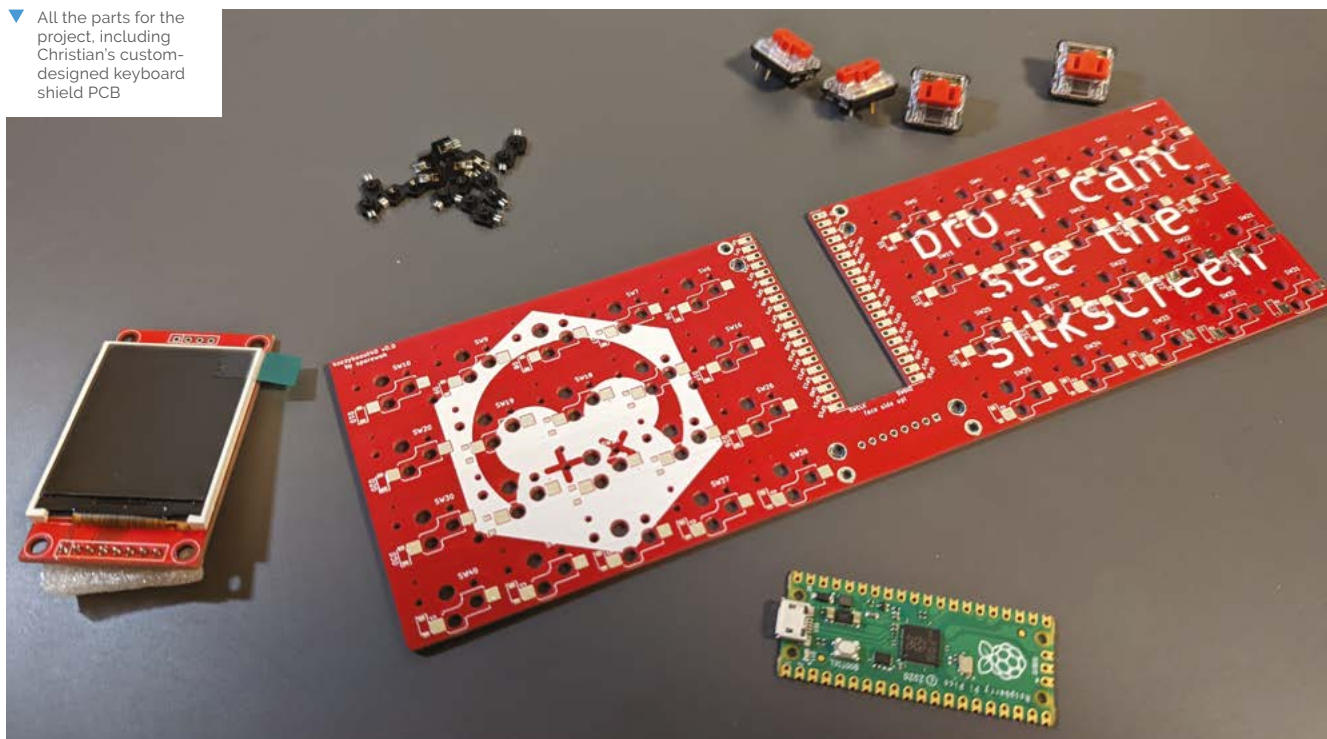



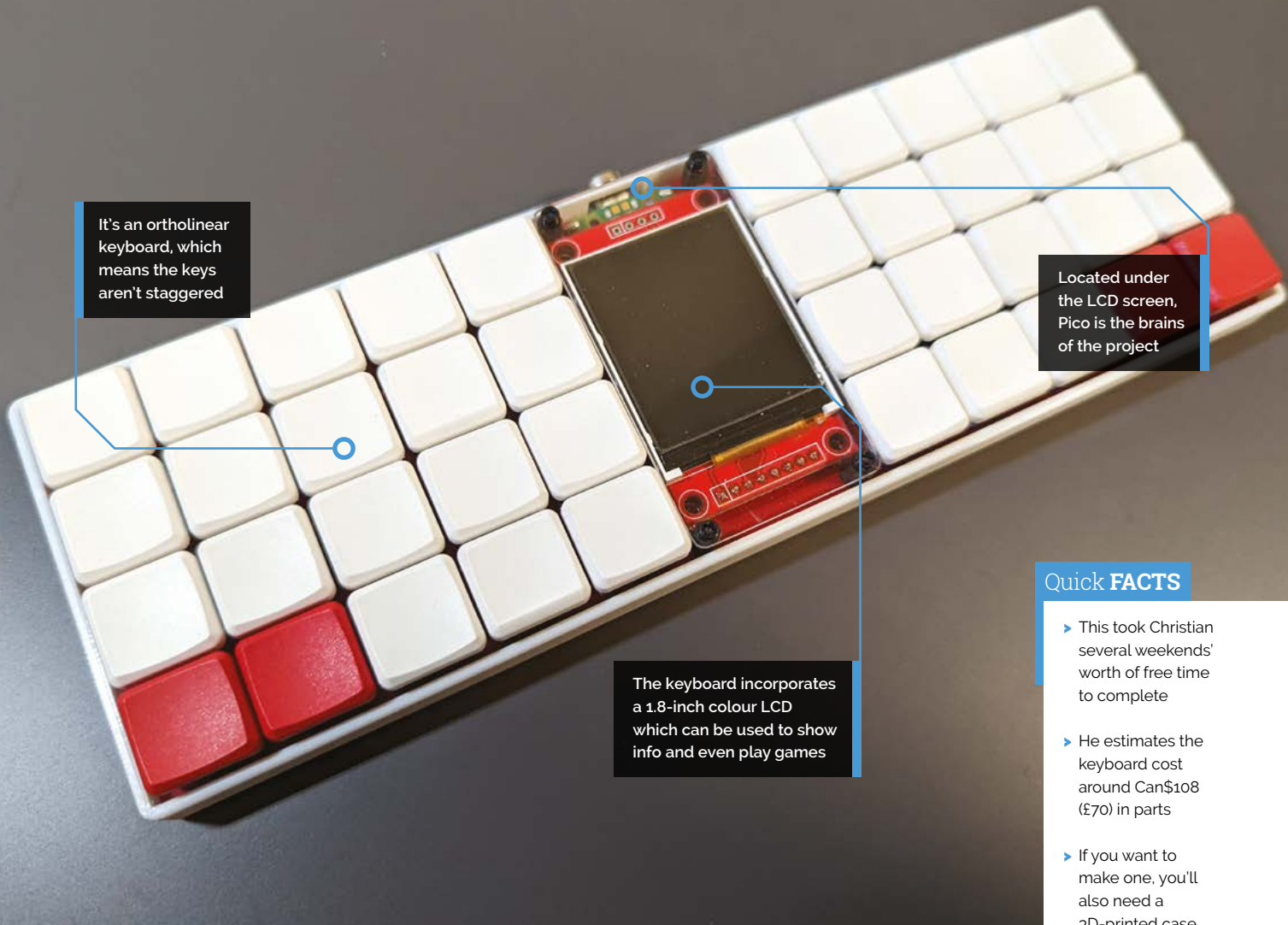

It's an ortholinear keyboard, which means the keys aren't staggered

Located under the LCD screen, Pico is the brains of the project

The keyboard incorporates a 1.8-inch colour LCD which can be used to show info and even play games

### Quick FACTS

- ▶ This took Christian several weekends' worth of free time to complete
- ▶ He estimates the keyboard cost around Can\$108 (£70) in parts
- ▶ If you want to make one, you'll also need a 3D-printed case..
- ▶ ..while the laser-cut acrylic screen cover is optional
- ▶ Christian has an upcoming design with Pico that uses two OLED displays!

in designing PCBs, he learnt a lot from the process. "One of the challenges was trying to learn to make custom footprints for the LCD, since I couldn't find one I could download off the internet."

In addition, he had to learn to code the Rust firmware. Programming plans for the Keezyboost40 include a Tamagotchi-style digital pet, as he created one previously at university. He'd also like to try making some basic games, "since the idea of having a keyboard double as a controller is an exciting idea to me." The use of Pico also means there's scope for programming with MicroPython.

### Pico potential

"Friends and co-workers have thought [Keezyboost40] is pretty cool!" says Christian. They were wowed by a video he showed them of it playing an animation, and the keyboard maker community have also been enthusiastic, with some people already making their own versions. The open-source code is available at [magpi.cc/keezyboost40](https://magpi.cc/keezyboost40). "I think some of them were just as excited as I was in terms of what possibilities an LCD screen could bring."

There's no stopping Christian in his Raspberry Pi and Pico plans. His enthusiasm for cutting-edge keyboards means he has conjured up plenty of ideas for future makes. "I think Raspberry Pi Pico

“ Pico was actually the near absolute perfect microcontroller for this project ”

and RP2040 are picking up a lot of traction in the keyboard community, so I'd love to use them in future keyboard designs," he says.

Regarding Raspberry Pi Zero W, he believes it would be fun to try to "stuff one of those into a keyboard with a similar form factor, and make it more of a cyberdeck... with WiFi, Bluetooth, and its own operating system." Pioneering in his use of Raspberry Pi boards and Picos for keyboards, Christian emphasises, "The sky would be the limit as to what you could do with it!" 

# Tiny System Monitor

Dmytro Panin has developed a pocket-sized device which allows him to constantly monitor his computer's performance, as **David Crookes** explains



**Dmytro Panin**

MAKER

Dmytro Panin is a programmer based in Kyiv, Ukraine, and he wrote his first line of code aged eight. He works for a large provider of nearshore software engineering services.

[magpi.cc/tsmgit](http://magpi.cc/tsmgit)

▼ Dmytro says the host program would need to be tweaked slightly to work with Windows and Linux

**A**t first glance, this ingenious little device appears to be performing a spot of magic.

You can see that it's gathering information about a computer's CPU, GPU, RAM, and SSD usage, and it's also discovering details about the machine's network activity and CPU temperature. Yet it only seems to be attached to the MacBook Pro's lid, so how does it gain the relevant info?

Well, the secret lies in what you cannot see – a hidden USB cable positioned behind the lid connecting the Pico Display Pack to the computer. This ensures the relevant information can be shown on a 1.14-inch LCD screen via a Raspberry Pi Pico board. But even this revelation doesn't diminish Dmytro Panin's achievement. Indeed, the project was more challenging than you may imagine.

## Revealing performance

Dmytro's motivation for creating this device was clear. "I wanted to see how my laptop performed when I was using full-screen apps,

mainly 3D rendering software and games," he tells us. "I wanted to be able to fine-tune all of the parameters, including the fan speed, to make sure that I could get the best performance, while ensuring my system would not overheat or throttle."

Although he could have used an additional monitor for this, he didn't have one to hand. He did, however, have a Raspberry Pi Pico board and the display pack. "As always," he adds, "I was just using what was available to me at the time."

Thankfully, the hardware side of the project proved to be straightforward enough. "The coding was the part that took the bulk of the build," Dmytro says. "Partially, it had to do with the fact that I decided to go with CircuitPython this time. I hadn't used it prior to this build, and I've only used MicroPython or C to program Raspberry Pi Pico."

## Tricky times

The idea was to create a CLI utility on the host computer to monitor the system characteristics and send the combined binary data over USB to the Tiny System Monitor which, in turn, dynamically adjusts the gauges to the new values. "The host program sends the data once a second to minimise its impact on the host system," Dmytro says. "I also installed an additional LED which glows red when I'm busy. It means people around me know not to disturb me when I'm on a video call."

The main challenge – "the one that did my head in" – was getting around the Mac's transition from Intel processors to Apple silicon. "I couldn't get the system-on-chip (SoC) temperature via any system tool," he says. "Eventually, I found a piece of code in Objective-C that taps into the system's API and produces the data I need. As I settled on Python for the host command-line (CLI) tool as well, it wasn't ideal that part of the host software was using another language, but it had to be done."

But how does the device attach to the computer? "MacBooks have two magnets in their lids on





The device is connected to the computer using a USB cable. It draws power from the MacBook Pro as well

Dmytro has used a magnet from an old camera lens to attach the device to his MacBook Pro

The client receives data once a second, and it fills in the gaps for a smooth-looking transition from old value to new

**Quick FACTS**

- ▶ The project can be recreated for about £20
- ▶ Dmytro has made a 3D model available for print
- ▶ The software is written in CircuitPython
- ▶ Data is sent to the Tiny System Monitor over USB
- ▶ All instructions/ code are on GitHub

“ I wanted to see how my laptop performed when I was using full screen apps ”

opposite sides – they are there for the laptop to know when the lid is closed,” Dmytro reveals. “So, I made use of those magnets and designed the project’s 3D-printed fitting to have a magnet of its own.” This also ensured the device can be positioned at eye level whenever he needs it. “Having something like this next to the laptop has been a game-changer,” he says. [M](#)

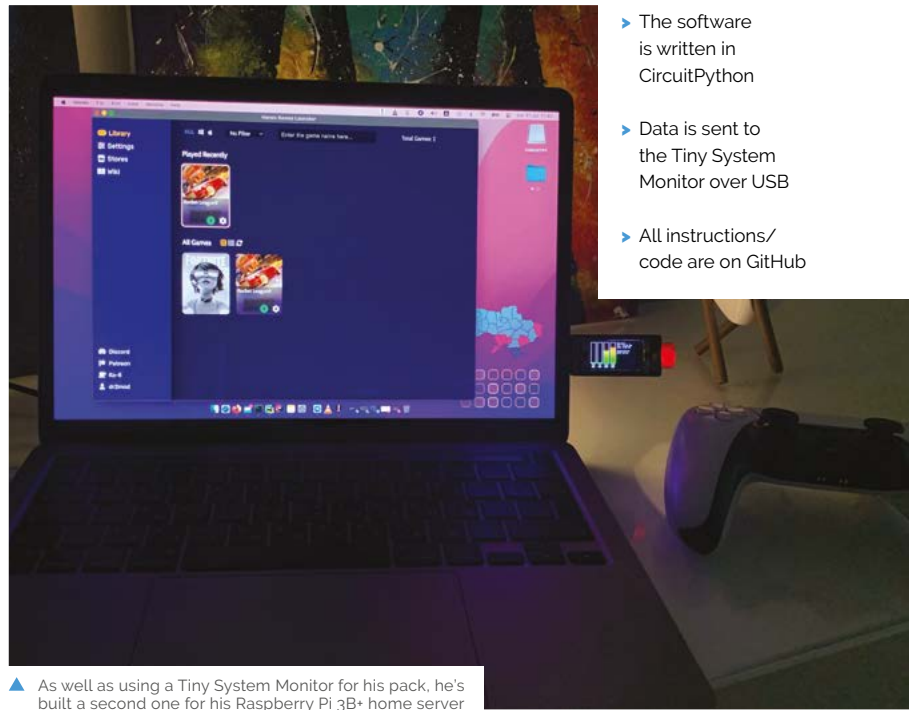

▲ As well as using a Tiny System Monitor for his pack, he’s built a second one for his Raspberry Pi 3B+ home server

# BMOctoprint

Building an OctoPrint server for your 3D printer is cool, but building it into a cute gaming robot body is much cooler, as **Rob Zwetsloot** finds out



## Allie Katz

Artist, technologist, maker, and YouTuber, Allie shoots videos of their creative adventures in a wide array of builder hobbies.

[magpi.cc/katzcreates](http://magpi.cc/katzcreates)

If you've ever seen *Adventure Time*, the strange and cool cartoon that started about twelve years ago, you might remember the sentient gaming robot and friend of the main characters, **BMO**. This cute retro-inspired, handheld robot has been made many times with Raspberry Pi to be an actual games console or interactive costume. However, Allie Katz, of Katz Creates, did something a little different.

"BMOctoprint is the portmanteau of BMO from *Adventure Time*, and OctoPrint, the 3D printing

server for remote access, and that is exactly what he is," Allie explains to us. "BMOctoprint is a life-sized replica of the beloved cartoon robot, powered by a Raspberry Pi 4, in a fully 3D-printed case, with functional buttons and a touchscreen face. He can basically control your 3D printer, whilst also giving you compliments and making you laugh, which officially makes him the best 3D printer server ever."

While looking for a case for their Raspberry Pi 4, a patron suggested to Allie that they could put it inside a BMO-shaped case. Allie loved the idea as they're a fan of BMO, who is a bit of a non-binary icon.

## Long time coming

"The build process – and, moreover, the design process – was extensive and rigorous for this because I knew from the get-go that I wanted to share the final plans online so others could make their own BMOctoprint," Allie tells us. "Designing and building something for yourself, that will be done once and never again, is a walk in the park compared to creating something that will be touched by the hands of countless others in a way that you cannot ever fully anticipate. User experience and accessibility are of paramount importance to me and, as such, I wanted BMOctoprint to be fun and easy to build, as much as possible."

The designs are made so they can be 3D-printed as easily as possible, and the whole thing has been documented on the Katz Creates YouTube channel.

With BMOctoprint connected to a 3D printer with a USB port, on boot it shows the OctoPrint GUI which can be controlled with the touchscreen.

"A lovely little idle animation works as a screensaver, meaning whenever you aren't actively

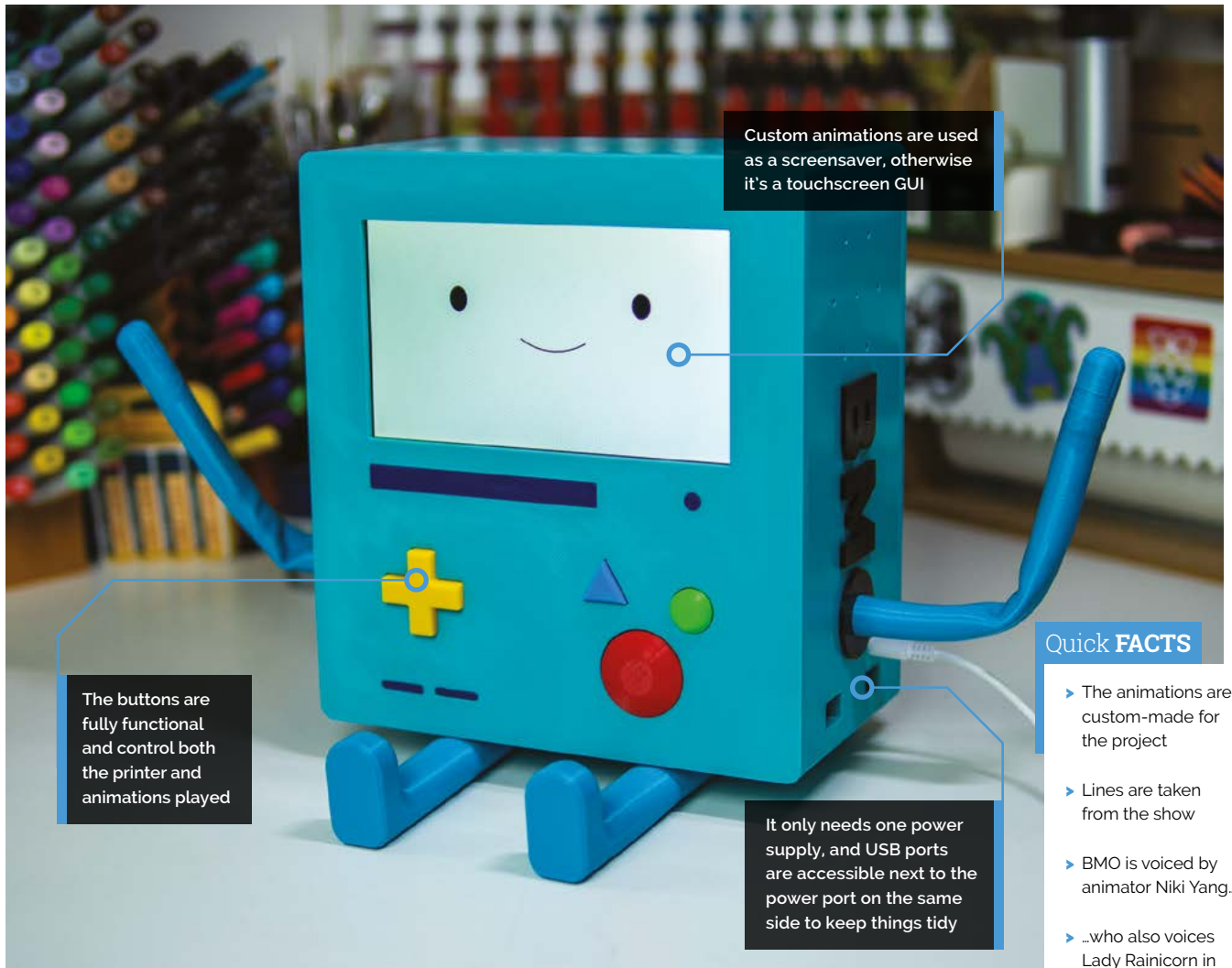

▲ All the electronics neatly fit inside BMO, leaving room to access and maintain as well

**Quick FACTS**

- ▶ The animations are custom-made for the project
- ▶ Lines are taken from the show
- ▶ BMO is voiced by animator Niki Yang..
- ▶ ..who also voices Lady Rainicorn in her native Korean
- ▶ All the files and code can be found here: [magpi.cc/bmctoprint](http://magpi.cc/bmctoprint)

“ User experience and accessibility are of paramount importance to me and, as such, I wanted BMOctoprint to be fun and easy to build ”

using the touchscreen, BMO wakes up and starts looking around,” Allie says. “The buttons on the right of the faceplate control the 3D printer and trigger a range of commands, from connecting to the printer to cancelling and pausing prints. The D-pad buttons are functional as well, but instead of controlling the printer, they each trigger a unique custom-animated reaction from BMO.”

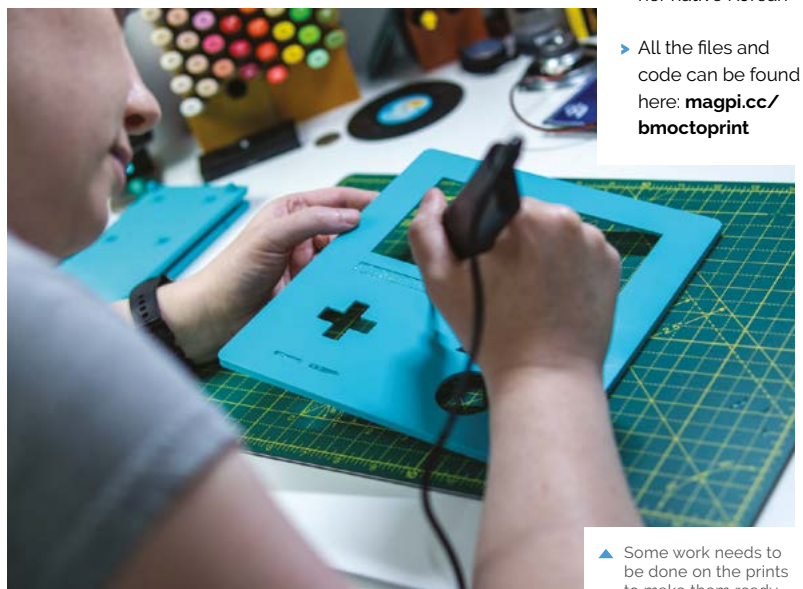

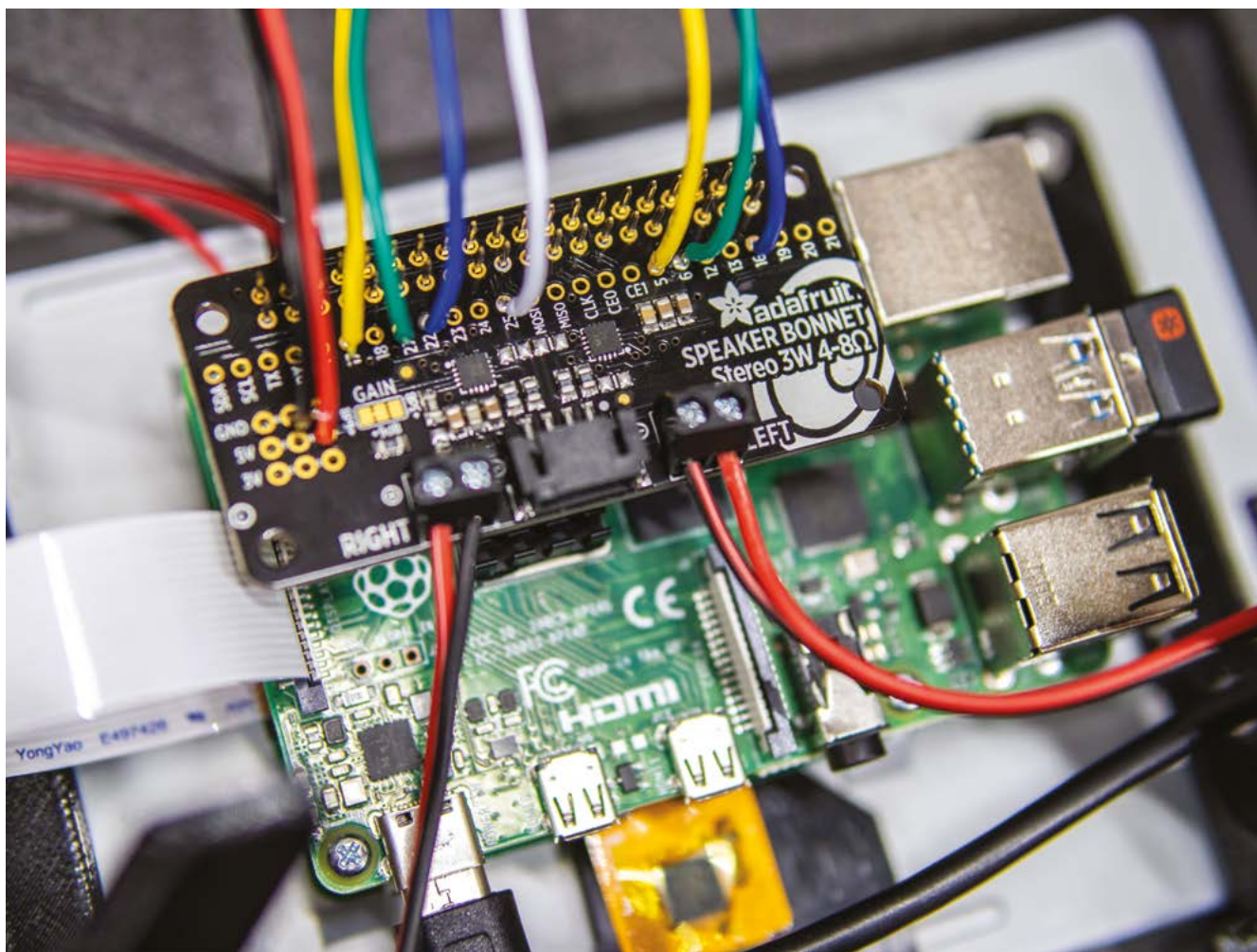

▲ The electronics are fairly simple, even using a custom PCB

▶ The buttons are fully functional, with the D-pad activating specific animations





## Distant future

We love the very clean and accurate look of BMOctoprint, and so do a lot of people in the wider maker community, if social media reactions have been anything to go by. While Allie hopes people will make their own, they're not done yet.

"I definitely want to add a Raspberry Pi Camera Module for watching prints, and have already accommodated this by adding a small slot in the back plate where the ribbon cable can fit through," Allie explains. "I also think BMOctoprint should have things he can hold, since there are magnets already places in the hands, though I have yet to come up with exactly what! I'm also pondering using a USB microphone to try adding voice activation into the mix, but that's still a wish list item at the moment!" 

▲ I/O ports are kept on one side so that everything is neat and easily accessible

## Making something for everyone

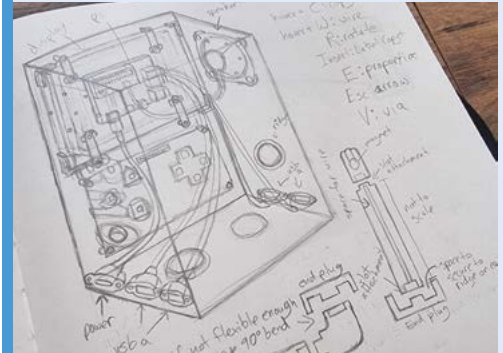

**01** Designing something that can be used consistently and easily replicated is very different from a one-off project. Allie spent ages on the design for BMOctoprint as a result.

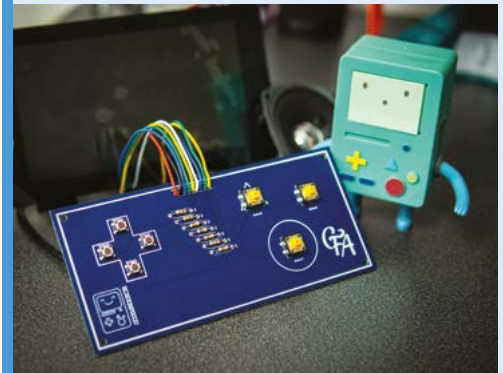

**02** Thoroughly testing the electronics is an important part of any build process, especially when using custom PCBs like Allie made.



**03** Making sure it can be constructed easily is also very important – sometimes you need to check the tolerances, especially with a 3D print.

# Raspberry Pi Beret

A classic song becomes a cool project, with this beret being powered by a Raspberry Pi Pico W. **Rob Zwetsloot** puts his journalist hat on to investigate



**Sean O'Steen**

MAKER

A software engineer, focusing on performance and reliability for a multinational supply chain software company. In his spare time, he does a lot of making.

[magpi.cc/picoberet](http://magpi.cc/picoberet)

**W**ay, way back in *The MagPi* 47, Alan McCullagh built a very special Raspberry Pi-powered beret, complete with a hidden camera and Prince symbol in an homage to the then recently-deceased pop icon. The Raspberry Beret joke has been around since even before Raspberry Pi came out, and with cosplayers and makers congregating in San Jose for SiliCon in August 2022, Sean O'Steen decided to do his own take.

"While not prepared for a full cosplay presentation like many other attendees at the convention, I certainly wanted to let my geek flag fly," Sean tells us. "Knowing that Raspberry Pi would be one of the companies with a booth at the convention, I wanted to pay homage to the people and the products that made possible most

of my home automation projects, and much of my journey into electronics self-learning. I used one of Raspberry Pi's latest microcontrollers, Pico W, and some addressable LED lights to create the Raspberry Pi Beret; the kind you won't find in a second-hand store."

The beret has two modes. When 'idle', the beret's LEDs light up around it with ever cycling animations at random intervals. With a phone connected to the wireless LAN on Pico W, Sean was able to control the lights from the web browser.

"Since the convention was going to be a busy place, I chose to make the animations about safety and traffic control," he explains. "I could signal my turns, my stops, and turn on my hazard lights if I planned to stay in one place for a while."

## First principles

If you follow Raspberry Pi on social media, you'll know that the team was showing off wearables that would be with them at the event. This gave Sean the idea to make the beret.

"As with most of my workshop projects that involve soldering or hot glue, I have some scars to show for my effort," he admits. "Assembling electronics that are flexible is always a challenge. The most significant challenge to building this hat was how do I hide the LED strips in a really small headband. Fortunately, I found an old black and white striped Lycra swim shirt; we call them rash guards around here. The LEDs shine brightly through the white stripes in the fabric, while the black fabric conceals the rest of the LED circuit board. If the lights aren't on, you might not notice that there are any electronics on the beret. Once the LED concealment was complete, the rest of the time was spent programming Pico W."

He made use of Alasdair Allan of Raspberry Pi's web server tutorial (in *The MagPi* 121) and a multi-threading video ([magpi.cc/picomt](http://magpi.cc/picomt)) from Bytes N Bits to make it speedy. On boot, the wireless chip is configured as an access point for the paired smartphone. One core of RP2040 handles the web service and phone requests, while the other core handles the animations – it's very elegant.

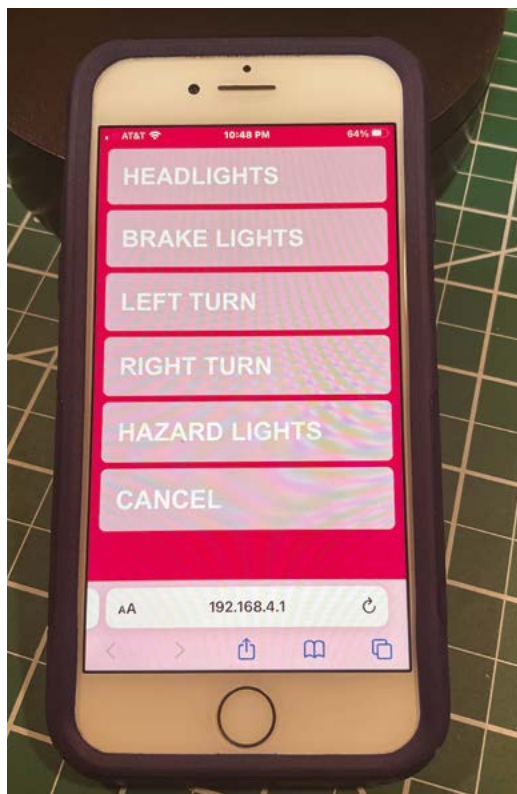

► This custom UI can be used to control the lights on the beret – in this case, they're traffic-themed for a busy convention



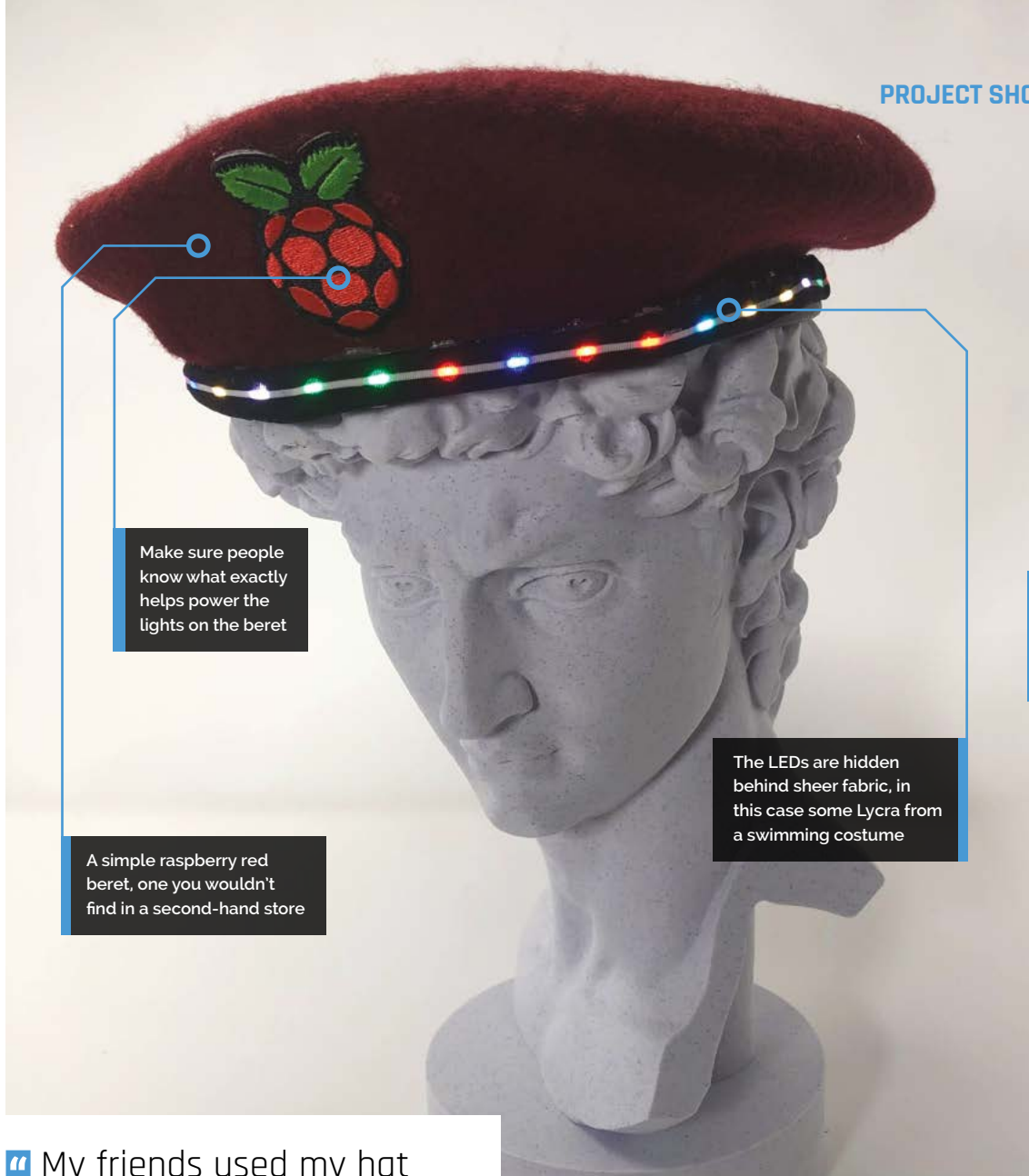

Make sure people know what exactly helps power the lights on the beret

A simple raspberry red beret, one you wouldn't find in a second-hand store

The LEDs are hidden behind sheer fabric, in this case some Lycra from a swimming costume

### Quick FACTS

- ▶ Sean used this project to learn about multi-threading on microcontrollers
- ▶ Even at 50% power, the LEDs are visible in daylight
- ▶ There are 37 NeoPixels on Sean's beret, but it depends on head size
- ▶ There is "several feet" of wire under the hat
- ▶ Sean created a custom CSS to give the UI a nicer look

“ My friends used my hat as a beacon to find me waiting in line outside the convention centre ”

### Heading to the future

“Before the convention started, my friends used my hat as a beacon to find me waiting in line outside the convention centre,” Sean tells us. “Once I got inside the convention centre, I received very kind feedback from many of the attendees. The team from Raspberry Pi spotted me from at least ten metres away as I approached their booth, and were thrilled to see the Raspberry Pi Beret in action.”

For now the beret will live on display in his office as a great reminder of a fun convention. It's also inspired his son to make a robot with some LED animations as well – we look forward to seeing Beretbot in the future. [M](#)



▲ The team at the booth immediately spotted Sean, so he came by to check out the projects

# SUBSCRIBE TODAY FOR JUST £10

Get 3 issues + FREE Pico W

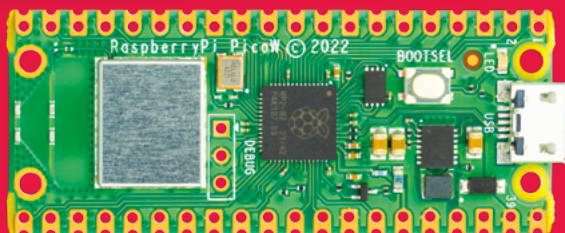

## Subscriber Benefits

- ▶ **FREE Delivery**  
Get it fast and for FREE
- ▶ **Exclusive Offers**  
Great gifts, offers, and discounts
- ▶ **Great Savings**  
Save up to 35% compared to stores

## Subscribe for £10

- ▶ Free Pico W
- ▶ 3 issues of The MagPi
- ▶ Free delivery to your door
- ▶ £10 (UK only)

## Subscribe for 12 Months

- ▶ Free Pico W
  - ▶ 12 issues of The MagPi
  - ▶ Free delivery to your door
- |          |                     |
|----------|---------------------|
| £55 (UK) | £90 (USA)           |
| £80 (EU) | £90 (Rest of World) |

☎ Subscribe by phone: **01293 312193**

📧 Subscribe online: **magpi.cc/subscribe**

✉ Email: **magpi@subscriptionhelpline.co.uk**

Subscribe for £10 is a UK-only offer. The subscription will renew at £30 every six months unless cancelled. A free Pico W is included with a 12-month subscription in USA, Europe and Rest of World. (No Raspberry Pi Pico W with £5 Rolling Monthly Subscription).

SUBSCRIBE TODAY AND GET A

# FREE Raspberry Pi Pico W

Subscribe in print today and get a **FREE** development board

- ▶ A brand new RP2040-based Raspberry Pi Pico W development board
- ▶ Learn to code with electronics and build your own projects
- ▶ Make your own home automation projects, handheld consoles, tiny robots, and much, much more



This is a limited offer. Not included with renewals. Offer subject to change or withdrawal at any time.



Buy now: [magpi.cc/subscribe](https://magpi.cc/subscribe)



**SUBSCRIBE**  
on app stores

From **£2.29**

Available on the  
**App Store**

GET IT ON  
**Google Play**



SUCCESS STORY [magpi.cc/success](https://magpi.cc/success)

# ECO Parking

Traffic lights work brilliantly on the roads, so why not use a similar system for parking? A Raspberry Pi setup allowed ECO Parking Technologies to do exactly that. By **Rosie Hattersley**

**T**he US is second only to China in terms of car ownership, with 276 million vehicles registered in 2020 (including motorcycles and vans; source: [magpi.cc/carownership](https://magpi.cc/carownership)). US Bureau of Transportation statistics show 91 percent of US citizens commute to work in a private vehicle, yet that same car or truck spends 90 percent of its time parked.

Urban car parking is big business, but many parking garages are used very inefficiently, in part because owners recognise the frustration associated with finding the elusive remaining parking spot in a nearly full car park. Instead, garages are “often shown as full once they reach roughly 90% of their capacity,” explains Jeff Pinyot, president and chief strategy officer of PGS (parking guidance system) company ECO Parking Technologies.

In some respects, this makes sense: if a customer has a poor experience and finds it time-consuming to locate a parking space or awkward to park, they’re unlikely to return,

and may even leave a bad review. Such are the negative connotations of time wasted looking for a parking place, the industry calls it ‘trolling’. The other waste, of course, is the 10 percent car parking capacity that isn’t being used and isn’t generating income for the site owner. Figures, helpfully provided by researchers at WGI Parking Group, estimate the cost of building a new car park in the US Midwest is in the order of \$35,000 per space, with parking garages typically housing 1000 vehicles – a \$35m investment.

## THE CHALLENGE

Parking garage owners benefit most from regular customers, often undercutting local rivals to attract them, at the expense of profits and money to invest in building improvements and renovations. The popularity of SUVs (sports utility vehicles) and a decade-long trend toward larger cars only exacerbate the issue; since fewer vehicles can park, while the expense of maintaining a confined downtown parking site continues to

rise. Outdated lighting and signage result: both of which may deter casual customers looking for a safe location to look after their expensive vehicle. Without significant investment, older car parking sites can easily enter a spiral of decline. Jeff Pinyot relates how the owner of a fairly outdated underground parking garage lost a quarter of his revenue because customers wouldn't park in the poorly lit lowest floor, but monthly-paying customers returned almost immediately, and for good, once reassuring, thief-detering LED lighting was installed.

ECO Parking Technologies identified each of these issues when trying to define a better way to bring existing parking sites up to modern standards at a cost that was manageable to proprietors. The company sells integrated LED lighting and parking guidance systems to the parking garage industry, and is a highly recognised name in the parking garage lighting business. CEO Andy Teed explains that they aim to help customers reduce energy consumption and vehicle emissions, while signage showing space availability enhances customers' parking experience.

ECO Parking's clients "desire real-time occupancy data to manage their garages," explains Andy Teed. "This data helps their customers find a parking space quicker, resulting in a better experience for their customer and reduced emissions from less drive time to locate a space."

An immediate benefit to the car park owner is that they can make use of the full capacity of the



“ An immediate benefit to the car park owner is that they can make use of the full capacity of the garage ”

garage, while a garage still in the planning stage no longer needs to accommodate 'dead space' that costs several million dollars to build, but doesn't generate income. There's an ecological benefit as well as a cost-saving here too.

Without the sort of solution ECO Parking offers, parking garage owners faced a loss of revenue, reduced customer service, higher energy consumption, and higher vehicle emissions.

### WHY RASPBERRY PI?

ECO Parking chose a Raspberry Pi-based setup due to its small footprint, low cost, and high quality. Other parking guidance systems update car parks by installing wireless communications involving bulky and expensive networking hardware, whereas the easily installed Falcon Vision package offered by ECO Parking is cheaper, quicker to install, and can be configured and managed remotely, meaning no on-site expertise is needed. The company was initially hesitant about choosing Raspberry Pi as they didn't know much about the security implications, but, says CTO William





Longardner, “it’s been a great experience for us”. Whereas Raspberry Pi 3B+ fitted into the design of ECO’s existing lighting range, upgrading to Raspberry Pi 4 will require a redesign. This is already being evaluated as part of ECO Parking Technologies’ plans for updating its Falcon Vision product line.

### THE RESULTS

ECO FlexTech saw controllable LEDs transform how car parks were lit, immediately improving a sense of security for customers and parking garage attendants. Based on a successful rollout, ECO Parking Technologies subsequently added wirelessly connected camera-based parking sensors that aid drivers, as well as informing them where and how many spaces they can choose from.

Raspberry Pi 3B+ fits snugly inside the shells ECO Parking had already designed, allowing the firm to quickly roll out the new Falcon Vision product.

Raspberry Pi 3B+ plays an important role, providing the LED colour-coded zoning system that directs drivers to available parking spaces, and whose colours can be changed throughout the day depending on occupancy requirements. Raspberry Pi operates seamlessly as part of the company’s cloud-based Edge IoT object detection setup, controlling the camera and adding wireless connectivity without the need for ugly retrofitted boxes that are prone to vandalism and need replacement or repair. ECO Parking’s customers can view real-time activity by logging in to their custom-designed software interface remotely.

“Our controlled LED fixtures can reduce power consumption between 20-80% depending on the type of fixtures being replaced,” says William. The lighting controls built into the Raspberry Pi-controlled IoT device can cut power consumption by another 30 percent. “We don’t have good statics on reduced vehicle emissions, but it stands to reason that if the average parker finds a space 25 percent faster, there will be a 25 percent reduction in vehicle emissions from the facility.”

Parking sites that deploy Falcon Vision not only make it easier for drivers to find a place to park; they also capitalise on the availability of slots used by residents overnight but not during the day. The colour-coded zoning system allows, say, purple zone residents’ parking to be used for green-zoned commuter, or retail park, visitors during office hours, simply by switching the indicator lights in the relevant bays. The zoning system easily accommodates changes in customer types, such as increases in demand for family and child slots at weekends, or ones for drivers dropping off welfare donations during the Covid pandemic. [M](#)

# HackSpace

TECHNOLOGY IN YOUR HANDS

THE **MAGAZINE**  
FOR THE **MODERN MAKER**



SUBSCRIBE AND  
**SAVE** UP TO  
**35%**  
on the cover price



ISSUE #60

# OUT NOW

[hsmag.cc](http://hsmag.cc)



# BUILD A SMART HOME

+ The wireless networking found in Raspberry Pi Pico W creates a whole new range of home automation possibilities. **PJ Evans** takes control

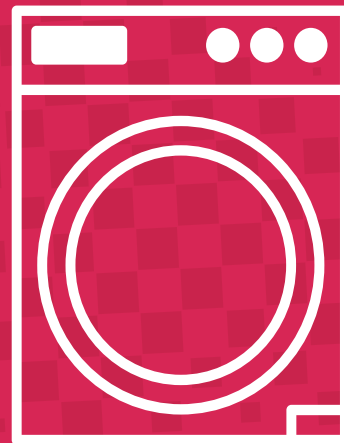



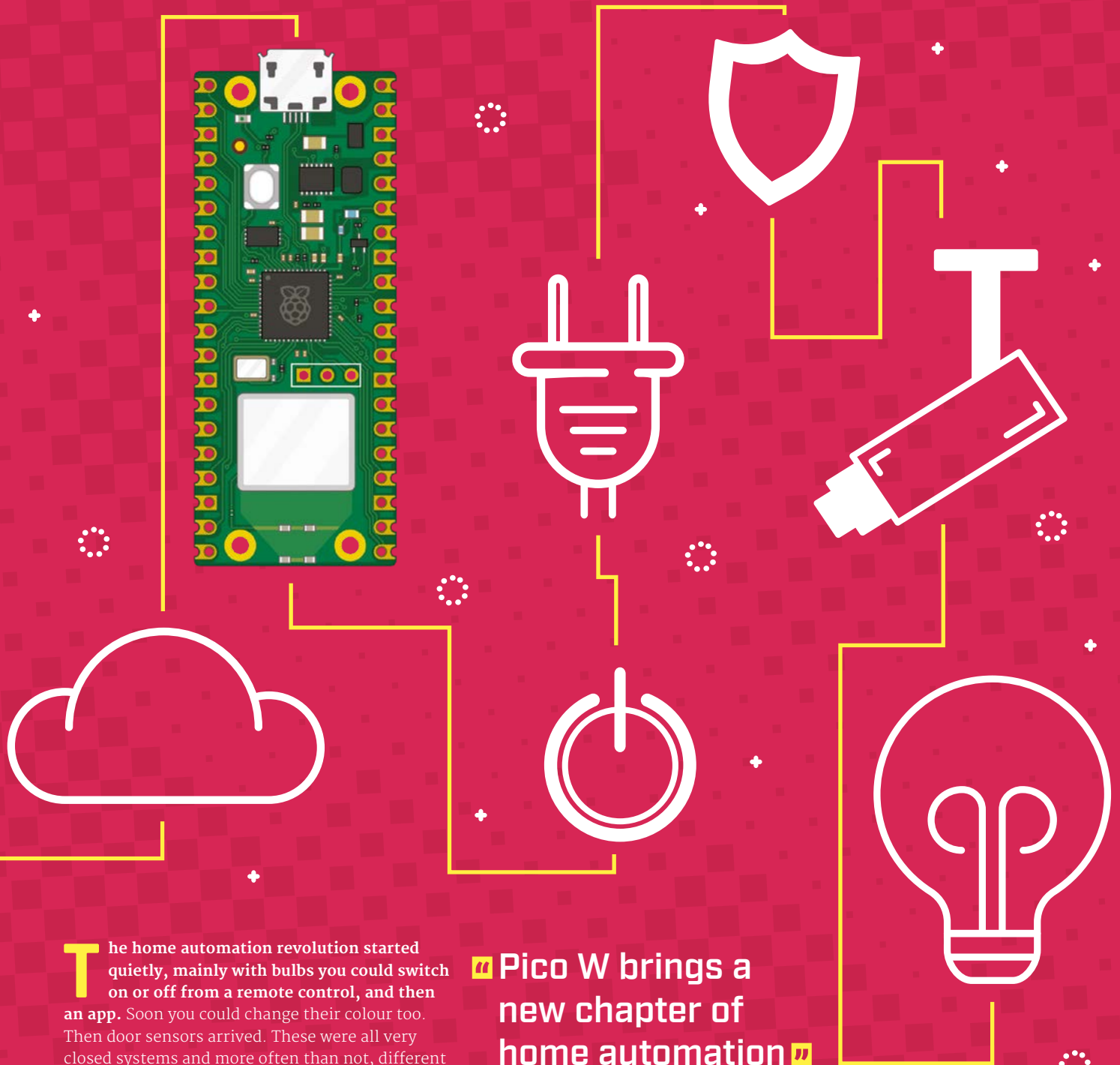

**T**he home automation revolution started quietly, mainly with bulbs you could switch on or off from a remote control, and then an app. Soon you could change their colour too. Then door sensors arrived. These were all very closed systems and more often than not, different suppliers' kits would refuse to talk to one another. Raspberry Pi computers, especially Raspberry Pi Zero, made DIY home automation easier than ever before and platforms such as Home Assistant provided the all-important orchestration layer allowing different systems to interact with each other and with homebrew devices. Now, Pico W brings a new chapter of home automation. Its size, power needs, and low price are all compelling factors, but it's also the ease-of-use that sets it

## ▣ Pico W brings a new chapter of home automation ▣

apart from other microcontrollers such as the ESP range. Add in the great documentation and community support and you have a platform that's perfect for making your own home automation projects. In the next few pages, we'll take a look at how Pico W can help you make your home smarter than ever before. We'll look at what kit is available, what others have done, and make your room smarter and more energy-efficient.

# PICO

# AUT<sup>🏠</sup>OMATION KIT TO BUY

To use your Pico W for home automation, you're going to need some sensors so it can see the world around it. Luckily, there is a huge range of Pico HATs and other add-ons so you can gather information and act on it. Here are some of our favourites.

## LoRA Expansion • £40/\$46

What if you want to monitor something far away? Whether it is wildlife at the bottom of your garden or the moisture level of the soil in your allotment, LoRA (long-range) radio technology is a great solution. With a decent antenna, LoRA signals can cover several miles. They're not fast, but they don't need to be if you're just sending basic data such as temperature. You'll need a LoRA receiver to collect the data, but with a battery setup and RTC (real-time clock) you could have a remote monitor with very low maintenance. The quality of the radio signal also makes it a great choice for fridge temperature monitoring.

[magpi.cc/picolora](http://magpi.cc/picolora)



## RFID Expansion • £25/\$28

Access control is a fun aspect of home automation. This RFID board allows you to read cheap RFID fobs and cards and take action based on the card. All RFID cards come with a unique code and you can capture this by placing the card to the receiver on the PCB (it's the same tech as contactless payment). As this verifies who is using the device, you can then use that information to trigger something custom to them, such as activating an electronic lock, adjusting the lighting to their preference, or playing their favourite tune. An OLED screen is also provided for visual feedback

[magpi.cc/picorfid](http://magpi.cc/picorfid)



“ A weather station is a common home automation project, mainly because it's a lot of fun ”

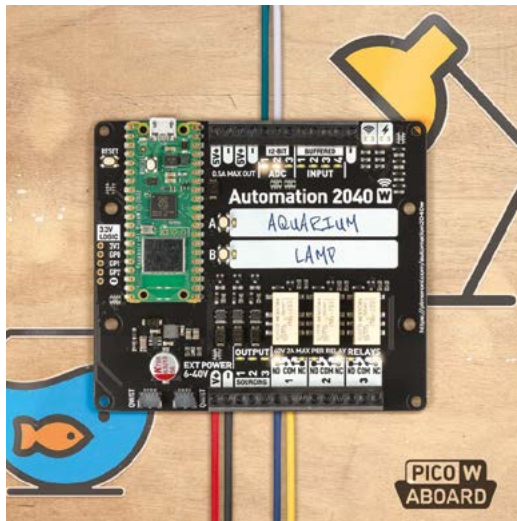

### Pimoroni Automation 2040 W • £59/\$54

A powerhouse of a board, this all-in-one from Pimoroni comes with a Pico W pre-soldered so you're ready to go. You can attach analogue sensors, control devices with the three on-board relays, and drive motors with three sourcing outputs. Plus two switches for control, two STEMMA QT connectors, and external power support for up to 40V. Pimoroni has clearly aimed this at the industrial market, but its wide range of inputs and outputs make it perfect for prototyping home automation projects. It's also great for 'stand-alone' automation since the Pico W can orchestrate the components, as you'll see in our tutorial.

[magpi.cc/automation2040w](https://magpi.cc/automation2040w)



### Enviro Weather • £120/\$111

A weather station is a common home automation project, mainly because it's a lot of fun and you can get up to all kinds of mischief connecting weather sensors to displays or triggering alerts when conditions change. You can also participate in citizen science, sending data to weather services. Weather sensors for the Pico W come in many shapes and sizes, but this unit from Pimoroni is the real deal. You can measure temperature, humidity, pressure, light, wind, and rain in a single outdoor unit. Plus, the deep-sleep mode means it can run on batteries for months.

[magpi.cc/envioweather](https://magpi.cc/envioweather)

## IOT RESOURCES

Here are some essential resources for the world of home automation

### Home Assistant

A free operating system for controlling your IoT devices and running automations.

[home-assistant.io](https://home-assistant.io)

### MQTT

This protocol is probably the most popular messaging system for home automation. Find out how to use it in your projects here.

[mosquitto.org](https://mosquitto.org)

### Home Automation With Raspberry Pi

This book is a comprehensive guide to controlling your home using apps, voice, and events.

[magpi.cc/homeautopic](https://magpi.cc/homeautopic)

### Maker Pi Pico • £8/\$7

For a simpler breakout board, consider this from Cytron. Maker Pi Pico allows you to use the universally popular Grove modules. These cheap and solderless boards are the easiest way to add a wide range of sensors and output devices to your project. The board also offers full access to the GPIO pins as well as a buzzer, audio out, three switches, and an microSD card socket. Great value for the price, but you will need to provide your own Pico W with headers. Another top prototyping tool.



[magpi.cc/makerpipico](https://magpi.cc/makerpipico)

### Pimoroni Inventor 2040 W • £35/\$32

This is another board that works well as a prototyping tool. More for the hobbyist than its larger cousin, the Automation 2040 W, the Inventor packs a load of useful inputs and outputs into a small form factor, with a Pico W board already soldered in place. It's designed for running off a battery, so can be useful for projects in more difficult locations. Breakouts are available for easy GPIO/ADC access, as well as an unpopulated slot for attaching one of the many boards from Pimoroni's Breakout Garden range. Finally, standard headers for servos are provided if your home project wants to go on the move.

[magpi.cc/inventor2040w](https://magpi.cc/inventor2040w)

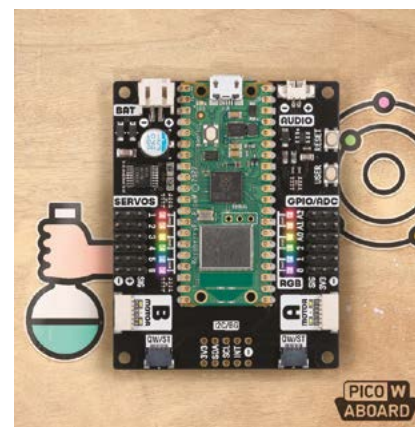

# PICO AUTOMATION PROJECTS

It's still early days for Pico W and home automation, but that doesn't mean makers haven't been busy. Already some impressive projects have started to appear. We've picked a few of our favourites here and hope these will inspire you to start your own Pico W journey.



## Garage door sensor

If you have a busy life, it's all too easy to leave your garage door open. Luckily, a simple magnetic reed switch (like the ones used in wired home alarm systems) provides an easy way to know the state of your garage door. Connect it up to one of Pico W's GPIO sensors and place both sides of the unit on the garage door and the adjoining wall. You can then trigger an alert or send an MQTT message to Home Assistant for further actions. This project by Jeff Geerling is a great beginner's challenge and very useful too.

[magpi.cc/picogarage](http://magpi.cc/picogarage)

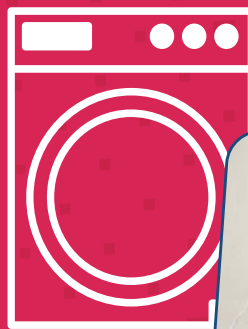

## Mark the plant

We love a project with a sense of humour, so when Sandeep Mistry wanted to give his houseplant, Mark, some personality, we were all-in. Using Pimoroni's Grow HAT with soil moisture sensors, he combined them with a Pico W to create a plant that sends text messages (using Twilio's API). Rather than the usual dashboard or pretty graph, Mark the plant is a bit more demanding and sends messages such as 'What a wonderful day to grow' or 'Some water would be nice'. Sandeep's extensive write-up allows you to grow your own. It's a great example of the joy of being creative with a make.

[magpi.cc/picoplant](http://magpi.cc/picoplant)

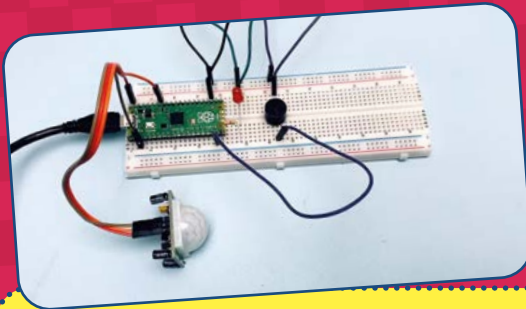

### Burglar Alarm

Another great starter project is the classic 'intruder alarm'. Normally, this just comprises a motion sensor and a buzzer; if motion is detected, the buzzer sounds. In this video, we go through the steps to wire everything up, then add some code to trigger the buzzer. With a Pico W, we can make this a bit more exciting. Try building this basic setup from Cytron and then altering the code to send a WiFi message to Home Assistant or send a notification using a service like Pushover.

[magpi.cc/picoburglaralarm](https://magpi.cc/picoburglaralarm)



### Home Assistant Starter

We've mentioned Home Assistant a few times in these pages. That's mainly because of its reputation as a great central server for all manner of IoT devices. Not only does it integrate with many common platforms such as Philips Hue or Ikea Trådfri lighting systems, but it's happy with homemade devices too. This starter project takes you through the steps required to get your Pico W hooked up to Home Assistant. Once complete, you can switch the LED on the Pico W on or off potentially from anywhere in the world. Now it's up to you to add more sensors and make it interesting.

[magpi.cc/hastarter](https://magpi.cc/hastarter)

▣ Rather than the usual dashboard or pretty graph, Mark the plant is a bit more demanding ▣

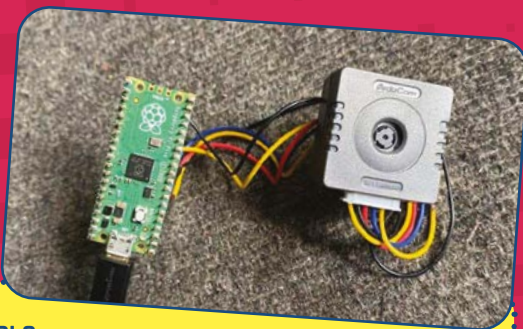

### SPI Camera

Being able to take photographs or stream video is a popular requirement for home automation. Room monitoring (for catching pesky siblings) may sound beyond the capabilities of a Pico W, but it is possible to stream low-res video and take photos. This is an in-depth project on how to get a 5MP SPI-based camera up and running on Pico W. It's a great insider guide to how the system works, even providing designs for a dedicated PCB. Step-by-step instructions make it as clear as possible, but this is probably not for beginners.

[magpi.cc/5mpcam](https://magpi.cc/5mpcam)



### Build your own weather station

Pimoroni's full weather station kits provide you with the ability to record many different types of weather data including wind, rain, temperature, and more. With an on-board Pico W, you can feed this data into one of the many citizen science websites to create a central pool of worldwide data, or you can create a home dashboard so you know whether an umbrella is needed today. This tutorial takes you through the full setup process for all the firm's Enviro boards, from small indoor systems to a full outdoor weather station.

[magpi.cc/getstartedenviro](https://magpi.cc/getstartedenviro)

# AUTOMATE YOUR ROOM LIGHTING WITH RASPBERRY PI PICO W



**MAKER** PJ Evans

PJ is a writer, software engineer, and tinkerer. His Raspberry Pi 4 knows more about his house lighting than he does.

[twitter.com/mrpjevans](https://twitter.com/mrpjevans)

## YOU'LL NEED

- + Automation 2040 W [magpi.cc/automation2040w](https://magpi.cc/automation2040w)
- + PIR Motion sensor [magpi.cc/pir](https://magpi.cc/pir)
- > Light sensor [magpi.cc/luxsensor](https://magpi.cc/luxsensor)
- + JST-SH to JST-SH cable [magpi.cc/jstsh](https://magpi.cc/jstsh)
- + 12V 2A PSU [magpi.cc/12vpsu](https://magpi.cc/12vpsu)
- + 5050 LED light strip with PSU [magpi.cc/5050led](https://magpi.cc/5050led)

+ Keep out of the dark with this simple tutorial that shows how you can use Pico W to perform actions when certain events occur

**W**hen starting out making your own home automation devices, one of the first projects you are likely to encounter is the ‘intruder alarm’. It’s great because it demonstrates that your device can understand an input and then trigger an output in response. We’re going to put a little spin on this and automate an LED light strip for your room based on movement and ambient light levels, then we can use Pico W’s internet capabilities so you can receive alerts when the lights have been triggered. Best of all, it’s a project that can be built upon to make it your own.

## 01 Prepare your Automation 2040 W

As the Automation 2040 W comes with the Pico W already soldered in place, this is a no-solder project! Before we get started, you need to install Pimoroni’s own ‘pirate’ brand MicroPython firmware. Take a look at the getting started guide at [magpi.cc/getstartedauto2040](https://magpi.cc/getstartedauto2040) and carefully follow the instructions to install the firm’s flavour of MicroPython. So we can use the ports on the board, you’ll also need to hook up a 12V power supply to **EXT POWER**. You may need to cut the barrel off the PSU or use an adapter. Always check the polarity with a multimeter!

## 02 Connect the motion sensor

We want to light up our cool LED strip when someone walks into the room. Our HC-SR501 PIR module will detect infrared heat from someone (or something!) entering the room. There are three lines: power, ground, and data. Here we have a problem. The HC-SR501 runs at 3.3V, but the Automation 2040 W requires 5V to register a signal. The solution is to treat it as an analogue device and use the ADC pins. Connect the power and ground to the **5V+** and adjacent ‘-’ pin on the board, then connect the data line to **ADC 1**. Tip: You can use male jumper cables; the screw terminals will accept them and it’s much easier than dealing with loose wire.

## 03 Connect the light sensor

If we just do motion detection alone, then once you’re in the room the lights may go off because you’re stationary. To solve this, we’re adding a light sensor. The Automation 2040 W comes with two STEMMA QT connectors, so with Adafruit’s VEML7700 light sensor module, we can use the JST-SH cable to easily connect it to the Pico W’s I2C bus. There’s no ‘wrong way of connecting it, and it doesn’t matter which port you choose. Now, with a little help from a MicroPython library, we can get accurate readings of the light

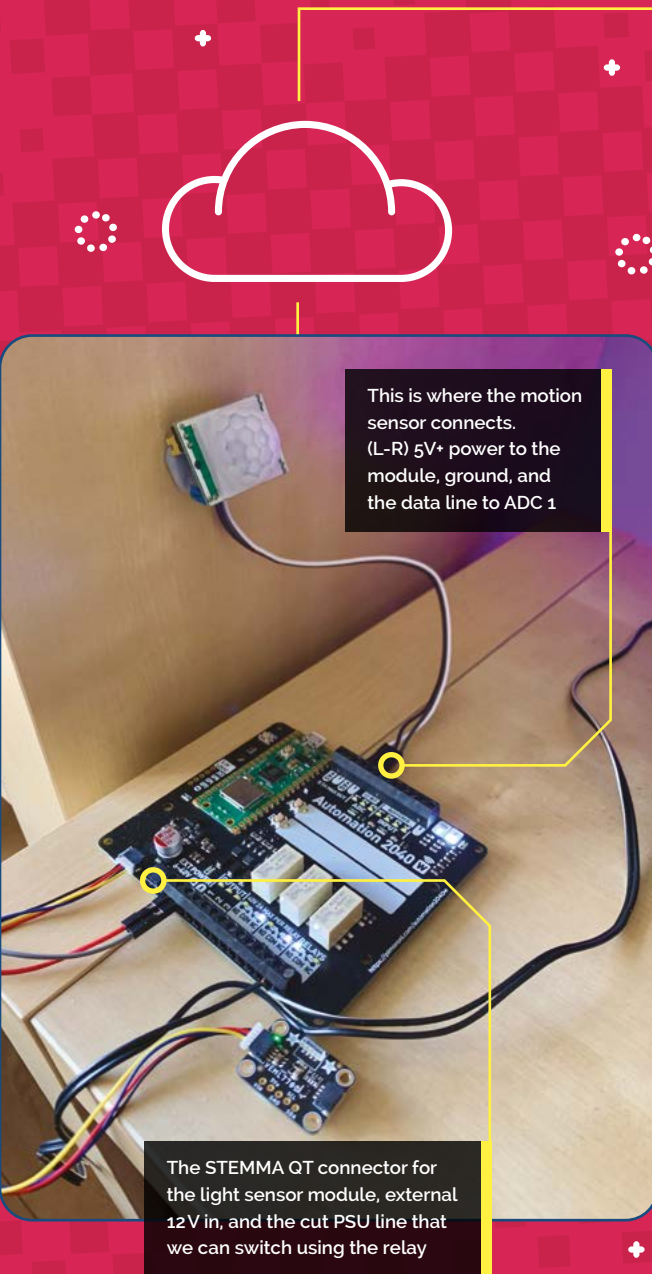

level. So, when you turn the main lights out, we can switch off the LED lights automatically.

#### 04 Connect the LED strip

There are many different types of light strips out there, so this step may vary. If you have a standard non-addressable 5050 strip, there's the option of powering it directly from the Automation 2040 W if you provide a suitable power supply. 5050s use 12V, but how many amps are required will vary. The easiest option is to use an additional power supply. We can use one of the Automation 2040 W's relays to safely switch the power. To do so, carefully separate out one of the two power lines from the other and cut the strip; connect one end to **Relay 3 COM** and the other to **Relay 3 NC**.



#### 05 Add the code

All the hardware is now in place to make our system work. Have a look at the **main\_relay.py** listing overleaf. Saving it as **main.py** means the Pico W will start the script immediately on boot. Using Thonny, or your favourite editor, enter the code (or download from [magpi.cc/mainrelappy](https://magpi.cc/mainrelappy)) and upload it to Pico W. With USB connected and in Thonny's environment, you will be able to see logging on what the Pico W is doing. You'll also see some variables you can alter to change light sensitivity, delays, etc. If all is well, waving your hand over the motion sensor should bring the lights on, and covering the light sensor will turn them off after five seconds.

#### 06 Now with added internet

This is a tutorial for the Pico W, so let's bring the internet in. Using the popular iOS/Android app Pushover, we can receive alerts whenever the lights are switched on and off – handy if someone tries to sneak into your room. Set up a free account at [pushover.net](https://pushover.net), get the API key (on your profile page), then download the app. Download the expanded version of the code from [magpi.cc/mainrelaypushoverpy](https://magpi.cc/mainrelaypushoverpy) and update the settings to match your WiFi network and Pushover. Now try triggering the lights again and see the alerts come through! 📧



#### TOP TIPS 🙌

##### Feeling sensitive?

If you find the motion sensor is too jumpy (or not jumpy enough), you can change its range by adjusting the sensitivity potentiometer. Here's a great guide: [magpi.cc/pirguide](https://magpi.cc/pirguide).

##### Advanced messaging with MQTT

MQTT is a messaging protocol that allows you to hook up all kinds of systems together. To add MQTT messaging to this project check this out: [magpi.cc/picowmqtt](https://magpi.cc/picowmqtt) and see the example here: [magpi.cc/mqttlightcode](https://magpi.cc/mqttlightcode).

## main\_relay.py

Language: **MicroPython**

DOWNLOAD  
THE FULL CODE:

 [magpi.cc/mainrelappy](https://magpi.cc/mainrelappy)

```

001. from automation import *
002. from machine import Pin, I2C
003. import time
004.
005. import veml7700
006.
007. board = Automation2040W()
008.
009. # Change these values to meet your needs
010. darkness_threshold = 50
011. delay_after_darkness = 5 # Seconds
012.
013. # Setup sensors
014. i2c = board.i2c
015. lux_sensor = veml7700.VEML7700(address=0x10, i2c=i2c, it=100, gain=1/8)
016.
017. led_strip_on = False
018. board.conn_led(False)
019. darkness_detected = False
020.
021. print("Running")
022. while True:
023.     # Check for motion only if the lights are off
024.     if not led_strip_on:
025.         motion_level = board.read_adc(0)
026.         if motion_level > 1:
027.             print("Motion detected, lights on")
028.             board.conn_led(True)
029.             board.relay(2, True)
030.             led_strip_on = True
031.         else:
032.             if lux_sensor.read_lux() <= darkness_threshold:
033.                 if not darkness_detected:
034.                     darkness_detected = True
035.                     print("It's dark!")
036.                     time.sleep(delay_after_darkness)
037.             else:
038.                 print("Still dark, lights off")
039.                 darkness_detected = False
040.                 board.conn_led(False)
041.                 board.relay(2, False)
042.                 led_strip_on = False
043.                 time.sleep(delay_after_darkness)
044.                 print("Monitoring again")
045.
046.     time.sleep(0.5)

```



# main\_relay\_pushover.py

Language: **MicroPython**

DOWNLOAD  
THE FULL CODE:

[magpi.cc/mainrelaypushoverpy](https://magpi.cc/mainrelaypushoverpy)

```

001. import network
002. import urequests
003. import json
004. from automation import *
005. from machine import Pin, I2C
006. import time
007.
008. import veml7700
009.
010. board = Automation2040W()
011.
012. # Change these to match your settings
013. ssid = "<Your wifi network name>"
014. password = "<Your wifi network password>"
015. pushover_user_token = "<Pushover user token>"
016. pushover_api_token = "<Pushover API/app token>"
017.
018. # Change these values to meet your needs
019. darkness_threshold = 50
020. delay_after_darkness = 5 # Seconds
021.
022. # Connect to wifi
023. wlan = network.WLAN(network.STA_IF)
024. wlan.active(True)
025. wlan.connect(ssid, password)
026. print("Wifi status: " + str(
wlan.isconnected()))
027.
028. # Setup sensors
029. i2c = board.i2c
030. lux_sensor = veml7700.VEML7700(address=0x10,
i2c=i2c, it=100, gain=1/8)
031.
032. led_strip_on = False
033. board.conn_led(False)
034. darkness_detected = False
035.
036. def pushover(message):
037.     print(message)
038.
039.     payload =
"token={}&user={}&title=Lights&message={}".
format(pushover_api_token, pushover_user_token,
message)
040.
041.     requests.post("https://api.pushover.net/1/
messages.json", data=payload)
042.
043.     print("Running")
044.     while True:
045.         # Check for motion only if the lights are
off
046.         if not led_strip_on:
047.             motion_level = board.read_adc(0)
048.             if motion_level > 1:
049.                 pushover(
"Motion detected, lights on")
050.                 board.conn_led(True)
051.                 board.relay(2, True)
052.                 led_strip_on = True
053.             else:
054.                 if lux_sensor.read_lux() <=
darkness_threshold:
055.                     if not darkness_detected:
056.                         darkness_detected = True
057.                         pushover("It's dark!")
058.                         time.sleep(
delay_after_darkness)
059.                     else:
060.                         pushover(
"Still dark, lights off")
061.                         darkness_detected = False
062.                         board.conn_led(False)
063.                         board.relay(2, False)
064.                         led_strip_on = False
065.                         time.sleep(
delay_after_darkness)
066.                         pushover("Monitoring again")
067.
068.         time.sleep(0.5)

```

# Build a MicroPython handheld



**K.G.  
Orphanides**

KG is a writer, developer, and software preservationist with a particular interest in projects that allow everyone to get hands-on with their own games and technology.

[magpi.cc/kgorphanides](http://magpi.cc/kgorphanides)

Jump into hardware hacking and gamedev at the same time with a purpose-built handheld that uses MicroPython as its game development platform

**Y**ouMakeTech's Vincent Mistler has produced some of our favourite Raspberry Pi Pico builds. This month, we're going to take a step-by-step look at building the 'Raspberry Pi Pico GameBoy' - a MicroPython-based handheld console that provides huge scope to develop your own games.

Vincent details the equipment you'll need and provides a video of the assembly process at [magpi.cc/buildpicogb](http://magpi.cc/buildpicogb) that you'll definitely want to look at. We've made a few tweaks and broken

down some undocumented steps to make the build extra easy, even if it's your first time making a project like this.

## 01 Prepare your hardware

To build our Pico-powered handheld, we'll use a 1.54-inch 240×240 Waveshare display module with an embedded ST7789 screen controller and a 3D-printed case designed by

### You'll Need

- ▶ Rotary tool with cutting disk and 2 mm drill
- ▶ Soldering station
- ▶ Flat face cutters
- ▶ Wire strippers
- ▶ Optional: 3D printer
- ▶ Parts: See list

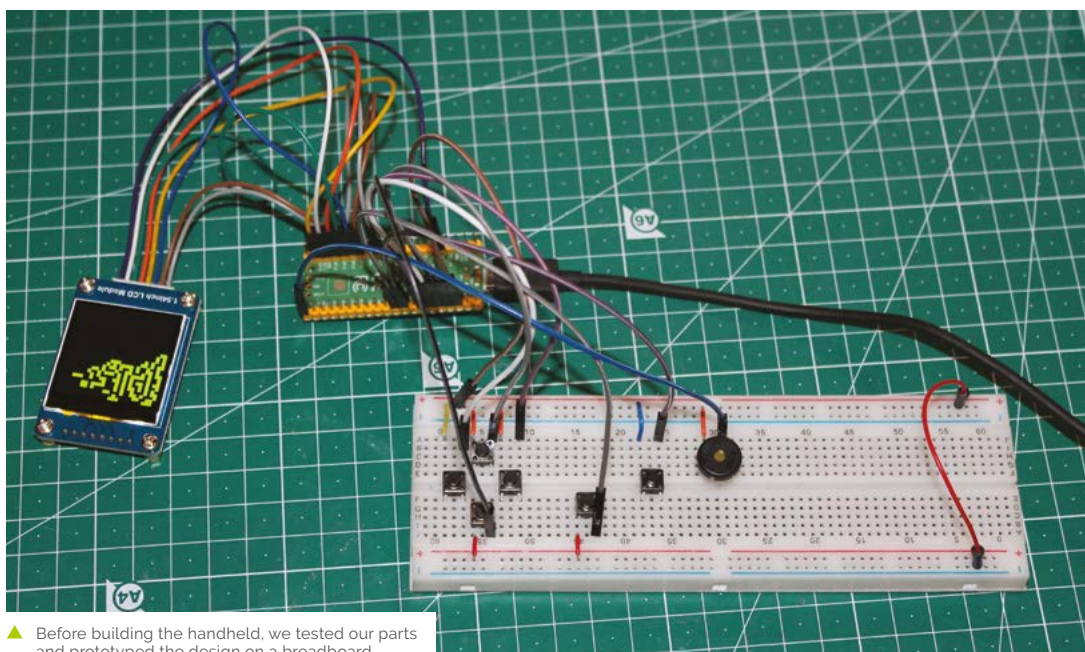

▲ Before building the handheld, we tested our parts and prototyped the design on a breadboard

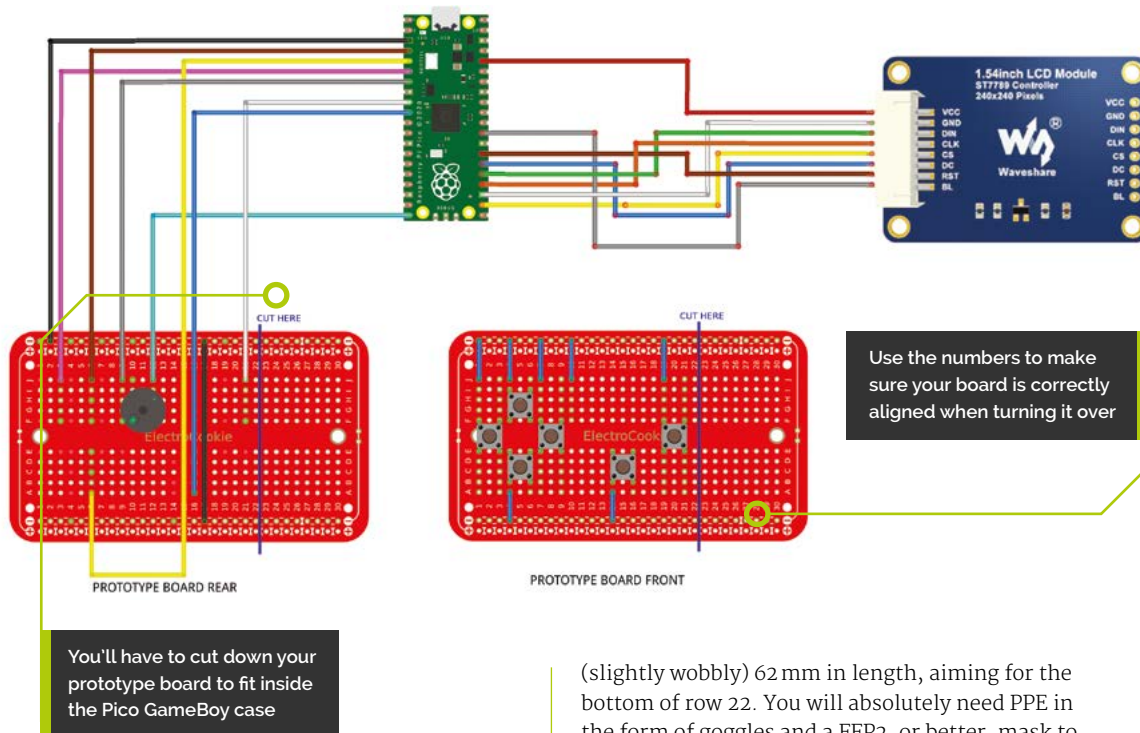

Figure 1 The wiring diagram for the handheld

YouMakeTech. We'll build our own control input and audio board. This calls for six 4-pin 6×6×6 mm tactile button switches and a piezo buzzer to make noises with, plus solderable prototyping breadboard and wire – see our shopping list (overleaf) for details.

## 02 3D-print YouMakeTech's case

This project starts with YouMakeTech's STL files ([magpi.cc/picogbstl](https://magpi.cc/picogbstl)) for the handheld's case, available to buy for £4 from Cults3D. The STL files include the top and bottom of the case, a D-pad, and a button – remember to print two of those!

If you're going to print these yourself, you'll find recommended settings at YouMakeTech's site ([magpi.cc/buildpicogb](https://magpi.cc/buildpicogb)). If you don't have a 3D printer, you can order them from a printing service. We ordered from a local printer via Cults3D's partnership with Craftcloud, which allowed us to directly send the STL models to the service before choosing the materials we wanted. We opted for PLA with a standard finish.

## 03 Cut your prototyping board

Once you've got the case, you can cut your prototyping board to fit the available space in the handheld's case. We cut our board down to a

(slightly wobbly) 62 mm in length, aiming for the bottom of row 22. You will absolutely need PPE in the form of goggles and a FFP2, or better, mask to help protect you from particulate matter. The best tool for the job is a Dremel with a cutting disc. A clamp isn't essential for this cut, but it'll make your life safer and easier. We used uPesy's medium solderable prototyping board, which measures 87 mm × 53 mm. ElectroCookie's solderable breadboard has similar dimensions, and is more readily available in the UK.

## 04 Measure and drill

You'll almost certainly need to drill additional 2 mm holes. This is so that the board can be mounted to a set of four pillars located inside the top half of the handheld's case, just below the hole for the display. Your breadboard will slightly overlap the back of the display when both are fitted. We needed two extra holes, positioned just at the number markers for row 21 on our board. This will be different on other brands, and you may need to drill all four holes on some. We took measurements against the 3D-printed case with the display in situ, made a template, and marked up the board with a paint pen. Wear your mask and goggles when drilling.

## 05 Buttons galore

We're using both sides of our solderable breadboard. On the front, we'll position six 6×6×6 mm, 4-pin, tactile button switches to line up



### Danger! Cutting tools

When cutting and drilling PCBs, wear protective goggles and an FFP2 or better mask.

[magpi.cc/cuttingtools](https://magpi.cc/cuttingtools)

## Top Tip

### Tape up

When cutting and soldering, use heat-proof masking tape to mark and protect adjacent parts of the boards.

► This build doesn't use that many parts, but it's a good idea to order extra prototyping boards in case of cutting errors

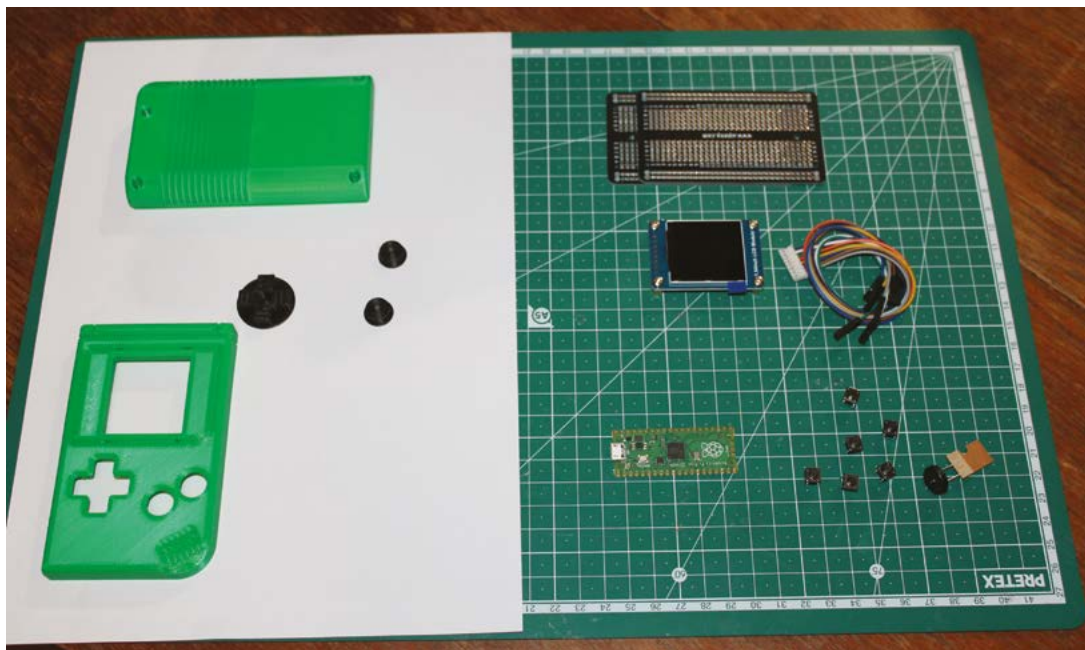

with the up, down, left, right, B, and A buttons. We strongly recommend carrying out fit tests before soldering to ensure that the buttons and D-pad on your board will line up with the holes in the case. The front of the board is also home to most of our ground connections, including for the piezo buzzer fitted to the rear of the board. We used short pre-cut jumper wires for these, but you can cut your own from solid core wire.

to use its on-board connector, and the connector cable it ships with, for use with headers. Snip the individual DuPont female connectors from the end of each wire and solder them to Raspberry Pi Pico. These wires are stranded, so you'll want to twist or lightly tin them with solder to make them more manageable before soldering them to Pico. Follow our Pico pinout connection chart (**Figure 2**) for where to solder each wire.

## Top Tip

### Prototype and test

We prototyped this build with a Pico H on standard breadboard before we started, and tested at various points during assembly to be sure everything was correctly connected.

## 06 Connect controls to Raspberry Pi Pico

We show both sides of the board separately in our diagram (**Figure 1**). The piezo buzzer goes on the rear so it doesn't obstruct assembly, although we've connected it to ground on the front. Also soldered at the rear is a wire bridging the upper and lower ground rails on the prototype board, soldered between the two negative rails on row 17. Most importantly, all the wires connecting the prototype board to Raspberry Pi Pico are also soldered at the back. We used solid-core wire to connect our input controls to Pico, at a length of around 80 mm. A different wire colour for each connection will help keep track of them, and you can use a helping hand to hold components in position while soldering, but our build went well without either.

## 07 Connect the display

Although the Waveshare display we're using has though-holes for soldering, we're going

## 08 Mount the display

The Waveshare display ships with four bolts and four brass standoffs attached to each of its

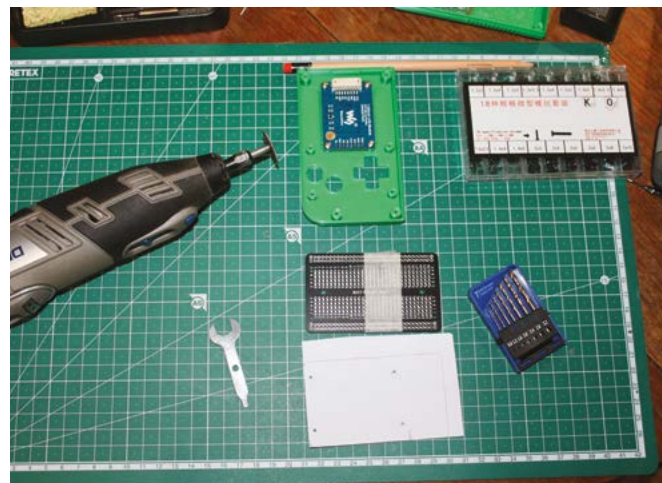

▲ Carefully measure and mark up the board before cutting, and don't forget to wear goggles and a mask to protect you against particulate matter

bolt holes. Remove these and hang on to the bolts. Turn the top half of the Pico GameBoy case upside down and line the display up with the case's four integrated plastic standoff pillars. The LCD display should face outwards, through the hole in the case, and the connector should face upwards. Use the bolts we set aside earlier to fix the display to the inside of the case. If you have any issues with standoff holes being misshapen or obstructed as a result of the 3D printing process, use a 2 mm drill bit to open them out before inserting the bolts.

## 09 Mount Pico and its controls

The mounting standoffs for Pico are on the rear half of the case. Use four 4 mm M2 bolts to screw the microcontroller into position, with its micro-USB port lined up with the hole in the case. With both display and Pico in position, it's time to mount the handheld's controls. If everything went well in step 3, our prototype board should be perfectly cut and drilled to fit the four standoffs on the case, just below the display. Drop your 3D-printed D-pad and buttons into their holes, then lower the control board into position so that its buttons line up with them. Ensure that none of the wires connecting the board to Pico are caught against the front of the case, and screw the board into the standoffs using four 6 mm M2 bolts.

## 10 Seal the case

Plug the display connector that you soldered to Pico into the Waveshare display, then carefully route the wires from this and the controller board to allow the rear shell of the case to be closed shut against the front half of the case. A lip creates a firm seal here. With the two halves properly fitted, drive four 8 mm M2 bolts into the holes that connect the back of the case bottom to the case top.

## 11 Transfer the files

We have a handheld! Now we need some software to run on it. Connect the micro-USB port to a Raspberry Pi or other computer with Thonny installed. Download MicroPython for Pico from [magpi.cc/rp2pico](https://magpi.cc/rp2pico), and copy it to the handheld using a file manager. At the command line, `apt install git` if you don't have it, then:

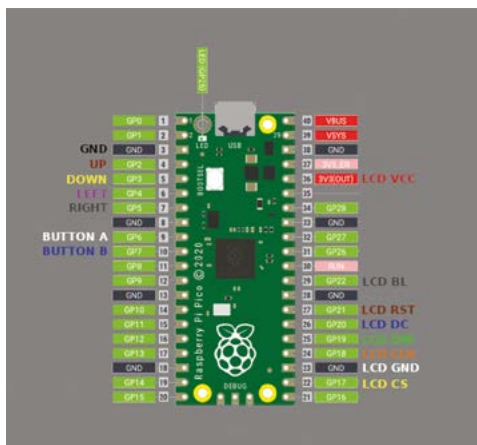

▲ **Figure 2** Both the controller board and LCD display are connected to Raspberry Pi Pico

## Shopping list

Item	Price
Raspberry Pi Pico GameBoy STL (£4). Only available from: <a href="https://magpi.cc/picogbstl">magpi.cc/picogbstl</a>	£4
Solderable prototyping breadboard. Get one that matches traditional breadboard configurations. Medium-sized uPesy and ElectroCookie boards meet the spec. <a href="https://magpi.cc/prototypeboard">magpi.cc/prototypeboard</a>	£12 for five
Waveshare 18079 1.55-inch LCD Display Module. <a href="https://magpi.cc/154lcd">magpi.cc/154lcd</a>	£10
4-pin tactile button switches 6×6×6 mm. You'll need six. <a href="https://magpi.cc/tactilebutton">magpi.cc/tactilebutton</a>	£2 for 20
Piezo buzzer. We used a TDK PS1240P02BT. <a href="https://magpi.cc/piezo">magpi.cc/piezo</a>	£5 for ten
Solid core electronics wire. Multiple colours are useful, but not essential. <a href="https://magpi.cc/elecwire">magpi.cc/elecwire</a>	£15 for multipack
Lead-free solder. 0.5 mm or your preferred thickness.	£7
M2 bolt kit. You will need four 4 mm, four 6 mm, and four 8 mm M2 bolts.	£10
Optional: Pre-formed jumper wire kit. <a href="https://magpi.cc/jumperwire">magpi.cc/jumperwire</a>	£10 for 560 of various lengths
Optional: 3D printer filament. Sunlu PLA+ is recommended.	£16 per 1 kg spool

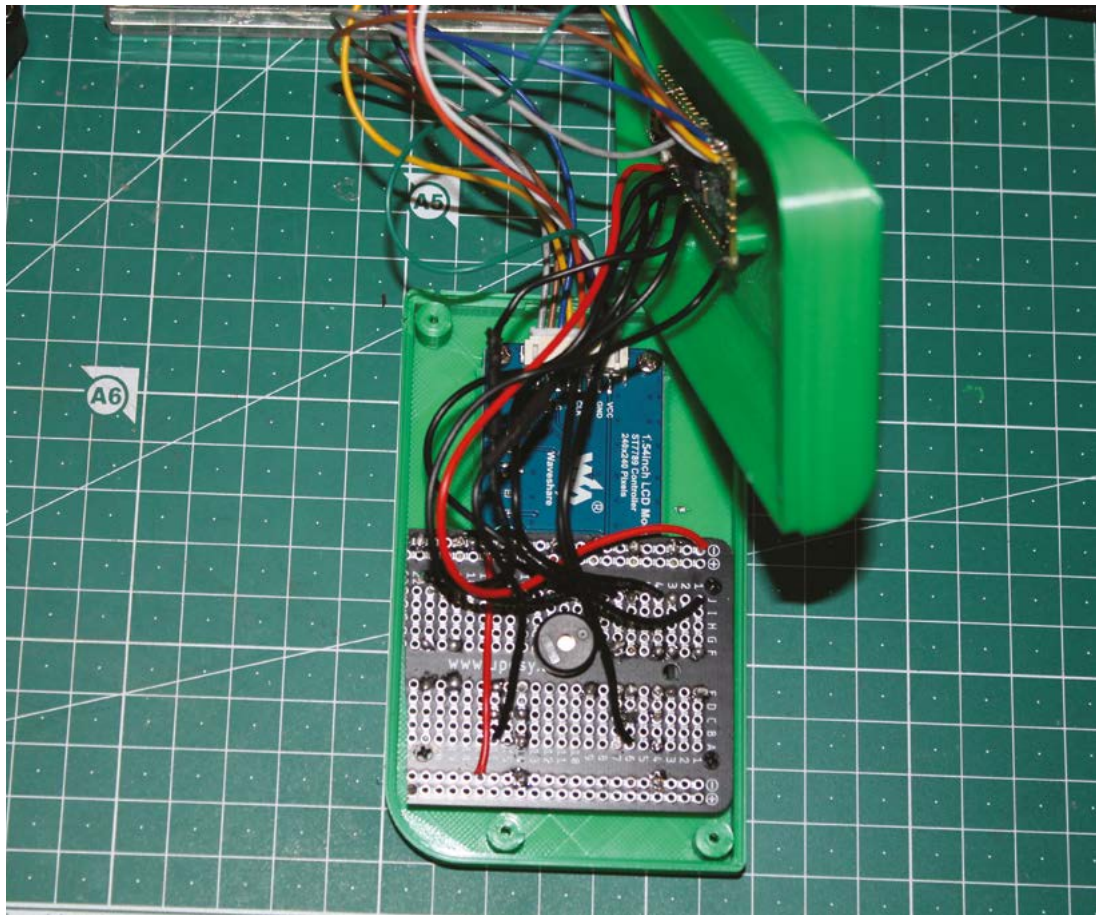

- ▶ With all the parts bolted into the case, all that remains is to carefully tuck your wires inside before closing and bolting it together
- ▼ The complete handheld requires external power, but it looks and feels very polished and is ready to develop games for



```
git clone github.com/YouMakeTech/Pi-Pico-Game-Boy
```

This repository includes library files to support development for the handheld, a version of Tetris by Vincent of YouMakeTech, and versions of the Game of Life and Flappy Bird by his son Matthieu Mistler.

## 12 Time to play

Open Thonny, making sure that it's in regular rather than simple mode, and that you've selected the MicroPython interpreter for Pico at bottom right. In the View menu, select Files, then use Thonny's file manager to drag all the files from the repo over to Pico. Open **tetris.py** from Pico and re-save it to the microcontroller as **main.py**. Press play to try the game. Pico's limitations give you clear parameters for developing your own MicroPython handheld games. YouMakeTech's games provide an example of what you can do with the console, from defining game areas and making sounds, to loading smart-looking title graphics like **tetris\_title.bin**. [🔗](#)

# Wireframe

Join us as we lift the lid  
on video games

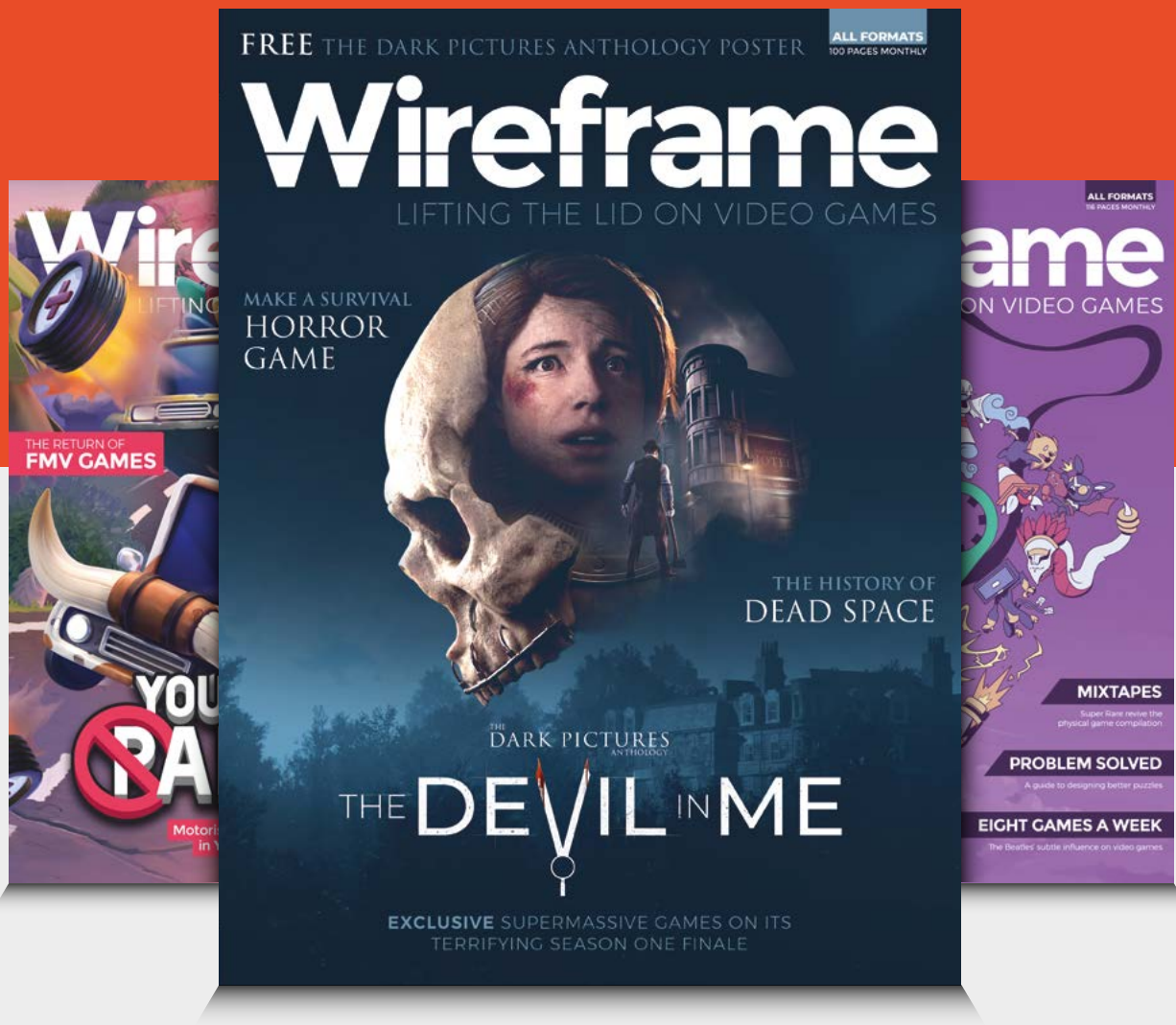

Visit [wfmag.cc](http://wfmag.cc) to learn more

# Pico W IoT with Anvil: Weather dashboard



**Phil King**

Long-time contributor to *The MagPi*, Phil is a freelance writer and editor with a focus on technology.

@philkingeditor

Send temperature and humidity sensor readings to display in an Anvil web app

**A**nvil's Pico W IoT toolkit enables you to connect easily, and securely, to web apps you create. Using the Anvil UF2 firmware image, you can code programs on Pico W in MicroPython, with a few extra lines to connect to Anvil, then create a web app on the Anvil site which can send and receive data to and from your Pico W program.

Last issue, we made an RGB LED mood lamp whose colour was controllable by moving sliders in an Anvil web app. That involved sending data to Pico W; this time we'll explore how to send data from Pico W to a web app dashboard to show temperature and relative humidity readings from a DHT11 sensor.

## 01 Install the firmware

If you already have a Pico W with the Anvil firmware installed and connected to your wireless network, you can skip the first two steps of this guide.

To be able to link your Pico W to the Anvil framework, you'll need to use Anvil's special firmware file. Go to [magpi.cc/anviluf2](https://magpi.cc/anviluf2) and download the latest 'complete' UF2 file. (If you want to avoid overwriting any existing files on Pico W, use the 'firmware-only' version.)

As usual, hold Pico W's BOOTSEL button while connecting it to a computer via USB, then drag the UF2 file to the mounted 'RPI-RP2' volume. Once it's copied across, Pico W will automatically reboot and reappear as a volume called 'Pico W'.

## 02 Connect to WiFi

With Pico W connected to your computer, open up the Thonny IDE and make sure the Python interpreter (shown at the bottom right) is set to 'MicroPython (Raspberry Pi Pico)'. The **main.py** file on Pico W will run automatically, so you will need to stop it by pressing the Stop icon. Open the **boot.py** file and enter your wireless router's SSID (name) and password at the top.

```
WIFI_SSID = "<put your network name here>"
WIFI_PASSWORD = "<put your WiFi password here>"
```

Now when Pico W reboots, it'll automatically connect to your wireless network.

## 03 Wire up the circuit

Place your Pico W on one end of a breadboard, as shown in the **Figure 1** diagram. The DHT11 sensor combines a digital thermistor with a capacitive humidity sensor and outputs digital readings, so it's easy to use. With the power turned off, connect the DHT11 sensor to Pico W as in the

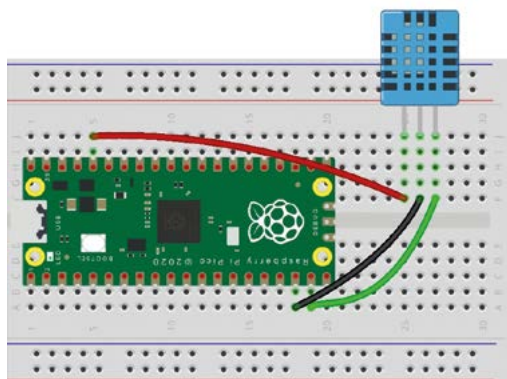

**▲ Figure 1** The wiring diagram for the circuit using a DHT11 temperature and humidity sensor

### You'll Need

- ▶ Raspberry Pi Pico W
- ▶ Anvil account (free tier) [anvil.works](https://anvil.works)
- ▶ DHT11 sensor [magpi.cc/dht11](https://magpi.cc/dht11)
- ▶ 3 × male-male jumper wires



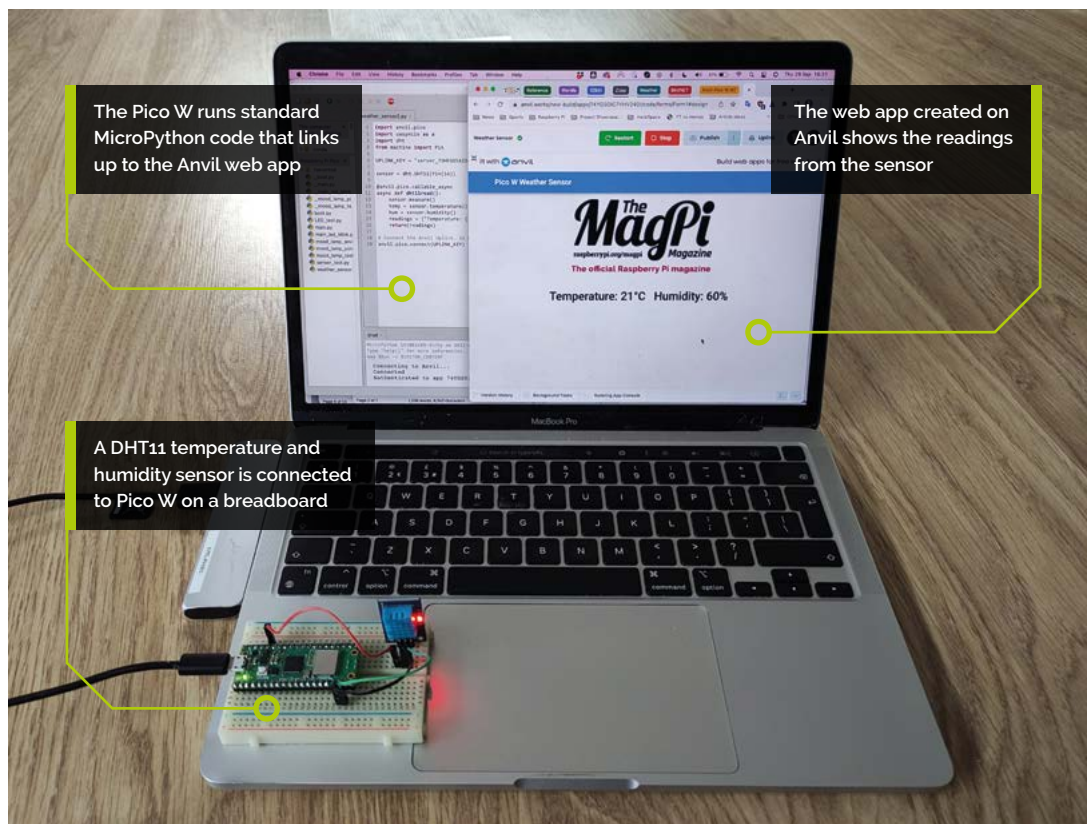

## Top Tip

### DHT11 pins

The pin order of different DHT11 sensors varies, so double-check the labels on the board when wiring it to Pico W.

diagram: power is supplied to its VCC by Pico W's 3V3 pin, GND is wired to GND, while the sensor's DOUT (digital out) pin is connected to GPIO 14 (you could use any GPIO pin).

## 04 Test the sensor

To make sure everything is connected correctly, we'll run a simple program on Pico W. Connect it to your computer via micro-USB, then open the Thonny IDE. Make sure the Python interpreter (shown at the bottom right) is set to 'MicroPython (Raspberry Pi Pico)'.

Open a new file and add the code from the `sensor_test.py` listing. At the top, we import the `dht` module for reading our DHT11 sensor, and the `Pin` class from the machine library so we can read the sensor from a GPIO pin. We create a variable, called `sensor`, and set it to take a reading from the sensor connected to GPIO 14.

```
sensor = dht.DHT11(Pin(14))
```

The `sensor.measure()` command is used to take a sensor reading. We then create variables for

“ The DHT11 sensor combines a digital thermistor with a capacitive humidity sensor and outputs digital readings ”

temperature and humidity and set them to the sensor values we just read. Since the DHT11's accuracy is 1°C and 1% humidity, there's no need to round the values.

```
temp = sensor.temperature()
hum = sensor.humidity()
```

To show the values in a more easily readable format, we turn them into a string to display:

```
readings = ("Temperature: {}°C Humidity:
{}% ".format(temp, hum))
print(readings)
```

Run the code and you should see the temperature and humidity readings from the sensor in the Shell pane of Thonny.

# CUSTOMPC

THE BEST-SELLING MAG FOR PC HARDWARE, OVERCLOCKING, GAMING & MODDING

THE MAGAZINE FOR

## PC HARDWARE ENTHUSIASTS



# ISSUE 230 OUT NOW

VISIT [CUSTOMPC.CO.UK](http://CUSTOMPC.CO.UK) TO LEARN MORE

## 05 Write the code

Now let's write the MicroPython code for our Anvil-connected weather sensor, as in the `weather_sensor.py` listing. The top line, `import anvil.pico`, enables Pico W to connect to Anvil's servers. The second, `import uasyncio as a`, sets up an asynchronous scheduler for running concurrent functions. We import the `dht` module and `Pin` class from `machine`, as in our sensor test code.

Further down is a line starting `UPLINK_KEY =`. This is where you will later need to paste the uplink key for the web app you create on Anvil so your Pico W program can link to it. At the bottom of the program is a line to connect using the key.

As in our test code, we create a `sensor` variable to take a reading from the DHT11 sensor connected to GPIO 14.

## 06 Callable function

This time, we'll create a function that will be called from the Anvil web app every few seconds. At the top, we add a 'decorator', starting with `@`, and also add `async` at the start of the line defining the function:

```
@anvil.pico.callable_async
async def dht11read():
```

This lets our connected Anvil web app know that this function is available to call from the web app. It's similar to our test function, but we add the line `return(readings)` to send the sensor data from Pico W to the web app.

## 07 Design the web app

If you haven't done so already, point your web browser to [anvil.works](https://anvil.works) and sign up for a free account. Create a new blank app and select a theme

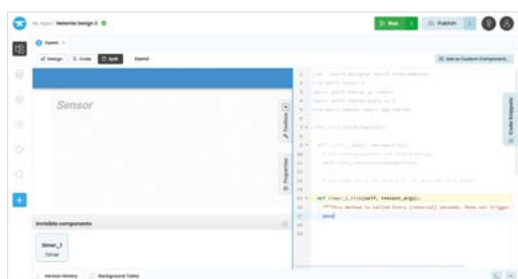

▲ You need to add a couple of lines to the code for the invisible timer element

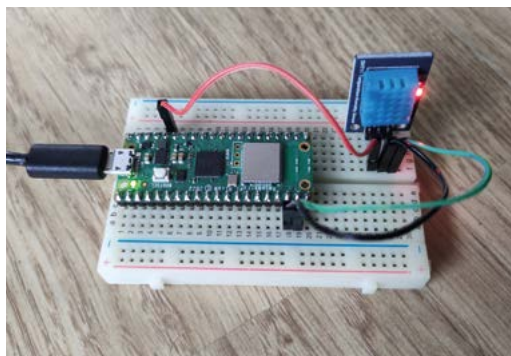

◀ The DHT11 sensor measures both temperature and relative humidity

– we chose the legacy Material Design.

From the right-hand Toolbox panel, drag a 'Display label – text' component over to the main panel of the app. This will be used to show our DHT11 sensor temperature and humidity readings. In the Properties panel, change its name to 'Sensor' – it will change itself to 'self.Sensor'. You can also set the font and size of the text in Properties.

## 08 Add a timer

While we could add a button to the web app to tell Pico W to run the function to send the sensor data, this wouldn't be very user-friendly. Instead,

“ The Timer is an invisible component, so won't show on the finished dashboard ”

we'll add a timer function to do it. In the Toolbox panel, click 'See more components' and then drag a Timer component below the Sensor label field. This is an invisible component, so won't show on the finished dashboard. In the Properties panel, change the timer's Interval value to 2 (seconds).

▼ Changing the name of the text field we'll use to show the readings

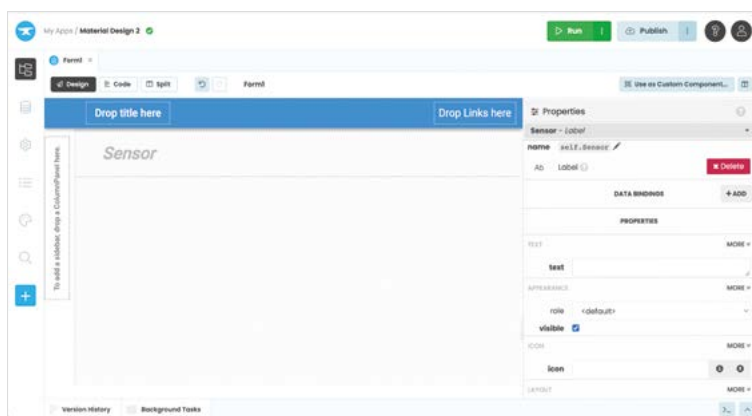

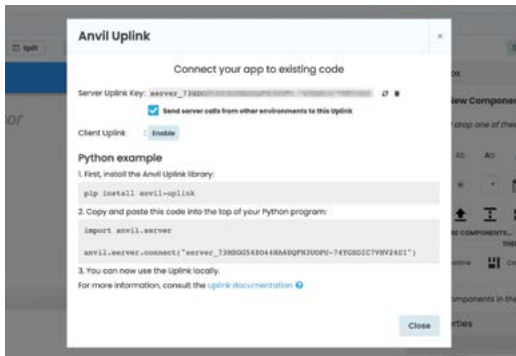

▲ Enable Server Uplink for your web app and then copy the key to paste into your Pico W program

Double-click the Timer element to bring up its code in a split-screen view. Before `pass`, add the following two lines (make sure they're indented):

```
data = anvil.server.call_s("dht11read")
self.Sensor.text = reading
```

The first line calls the `dht11read` function in our Pico W code, causing it to take a sensor reading. The second line sets the text of our `'self.Sensor'` web app field to the reading string created by the function, to show temperature and humidity.

## 09 Enable server uplink

Now to link our web app to our Pico W program. Click the '+' button at the bottom left and select Uplink, then click Enable Server Uplink. This will generate a Server Uplink Key for the app which you should paste into line 6 of your MicroPython code on Pico W so it can connect to it.

## 10 Run both apps

First, run your Pico W program in Thonny. You'll see messages in the Shell pane to show it connecting to Anvil. Once it has, run your Anvil web app. You should now see the temperature and humidity readings appear in its text field. To make your web app look a little more interesting, you can add a title and maybe a graphic (by pasting an image URL into the Source field). 🍷

## Top Tip



### Autorun code

To make your Pico W code run automatically upon bootup, save it as `main.py`. If you already have a `main.py` file, you may want to save that under another name first, to keep it.

## sensor\_test.py

DOWNLOAD THE FULL CODE:

 [magpi.cc/github](https://magpi.cc/github)

► Language: **MicroPython**

```
001. import dht
002. from machine import Pin
003.
004. # Set GPIO pin for sensor
005. sensor = dht.DHT11(Pin(14))
006.
007. # Take sensor readings
008. sensor.measure()
009. temp = sensor.temperature()
010. hum = sensor.humidity()
011.
012. # Turn readings into a string to display
013. readings = ("Temperature: {}°C Humidity: {}%
014.             ".format(temp, hum))
014. print(readings)
```

## weather\_sensor.py

► Language: **MicroPython**

```
001. import anvil.pico
002. import asyncio as a
003. import dht
004. from machine import Pin
005.
006. UPLINK_KEY = "<put your Uplink key here>"
007.
008. # Set GPIO pin for sensor
009. sensor = dht.DHT11(Pin(14))
010.
011. # Callable function for sensor readings
012. @anvil.pico.callable_async
013. async def dht11read():
014.     sensor.measure()
015.     temp = sensor.temperature()
016.     hum = sensor.humidity()
017.     readings = ("Temperature: {}°C Humidity: {}%
018.                 ".format(temp, hum))
018.     return(readings)
019.
020. # Connect the Anvil Uplink. In MicroPython, this call will
021.     block forever.
021. anvil.pico.connect(UPLINK_KEY)
```



# Get started with MicroPython on Raspberry Pi Pico

Learn how to use your new Raspberry Pi Pico microcontroller board and program it using MicroPython. Connect hardware to make your Pico interact with the world around it. Create your own electro-mechanical projects, whether for fun or to make your life easier.

- Set up your Raspberry Pi Pico and start using it
- Start writing programs using MicroPython
- Control and sense electronic components
- Discover how to use Pico's unique Programmable IO

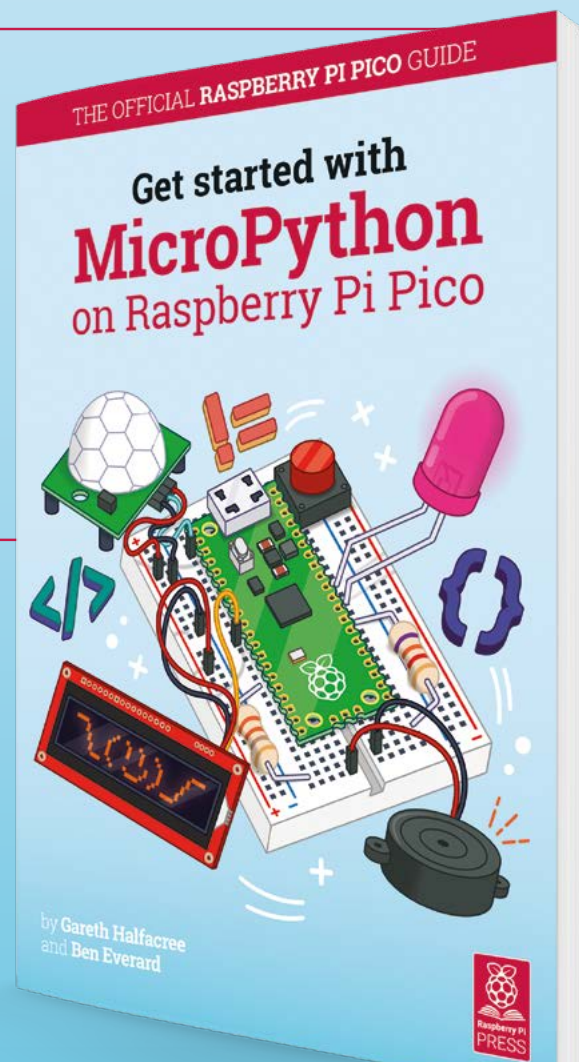

Available now: [magpi.cc/picobook](https://magpi.cc/picobook)

# Getting hands-on with relays

Find out all about these electromagnetic switching devices and use them in circuits



Mike Bedford

Despite loving all things digital, Mike admits to being a bit of a Luddite, vinyl records and all.

If you've dabbled with electronics, you'll know that a transistor is an electronic switch. What we mean by that is that it can turn one electronic circuit on and off by the presence or absence of a voltage in another circuit. You might have done just that, for example, to control a high-voltage or high-current device from a Raspberry Pi or Arduino. But the transistor wasn't the first electronic switch. That honour belongs to the valve, aka a tube, as we saw in HackSpace #48 ([hsmag.cc/issue48](http://hsmag.cc/issue48)) when we delved into these curious glowing components of old. Well, we now have to admit that even the valve

wasn't the first device to act as a switch, and that brings us to the relay, which is our subject here. To get our terminology right, it's not considered a fully electronic component, as transistors and valves are. Instead, it's an electromagnetic device. So, although it allows one electrical circuit to control another, just like a transistor, it does involve mechanics as well as electrics. Here, we'll look at how relays work, we'll show you how to put them through their paces on a breadboard, we'll see how to make a steampunk-esque relay-based contraption, and we'll investigate how they still have a place today – for example, for interfacing to single-board computers.

## INTRODUCING THE RELAY

So, how does a relay work? It's not difficult to understand, especially if we start with a diagram (Figure 1), which is a lot easier to follow than the ones that claim to explain how transistors work, holes migrating across P-N junctions and all. In the diagram, let's start by thinking about the part labelled 'electromagnet', which is a coil of wire wound around an iron core. When an electrical current is applied to the coil, the electromagnet becomes magnetic, and will attract iron objects towards it. In fact, there's an iron object just above the electromagnet, the part that's labelled 'armature', so it will be attracted to the electromagnet. Because the armature is angled and pivoted, this movement causes it to move the metallic strip shown as 'movable common contact', causing it to disengage from the normally closed contact ('NC') and engage with the normally open contact ('NO'). It will, therefore, have broken one electrical circuit, the one between the common and normally closed

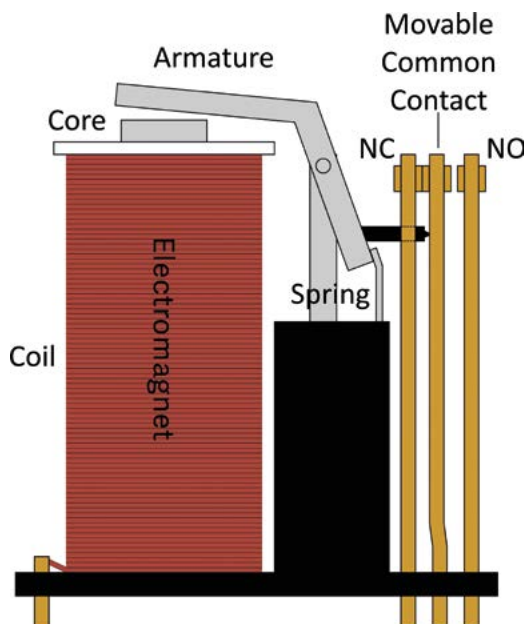

**Figure 1** Understanding how a relay works is a lot easier than getting your head around moving holes and electrons in transistors

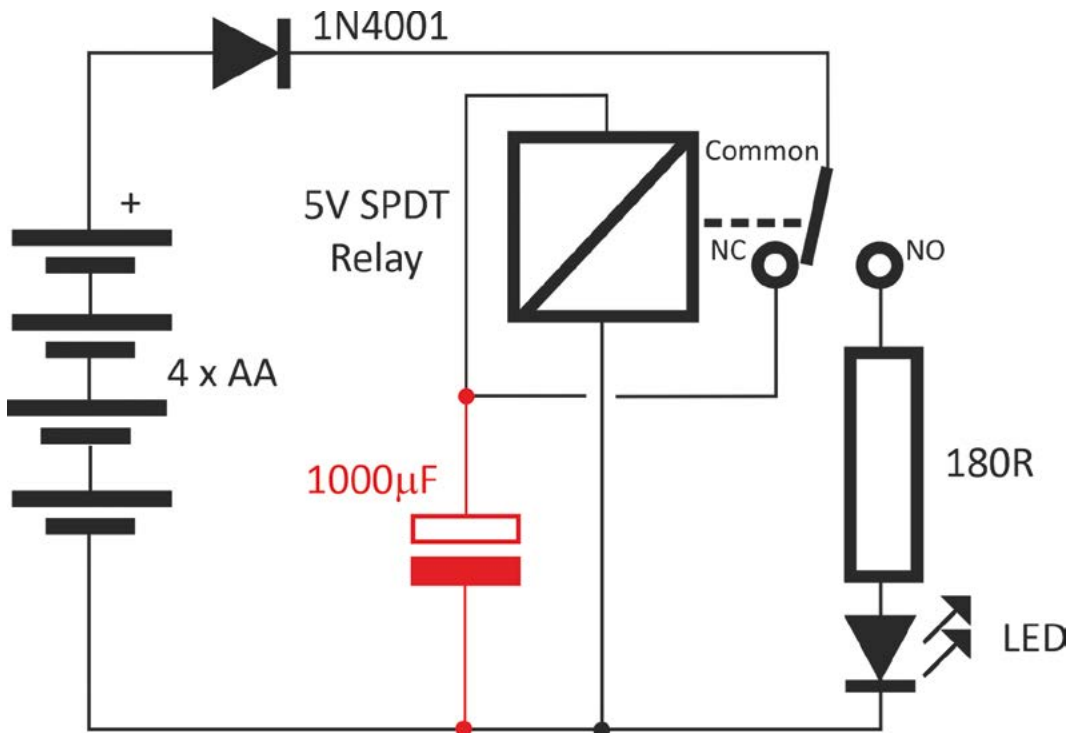

**Figure 2** ♦ We trust you'll be able to see that this circuit will act as an oscillator if the red capacitor is missing. And all you have to know to figure out how the capacitor slows it down is that the capacitor takes a while to charge up, so the relay will take a while to switch once a voltage is applied to it

contacts, and made another electrical circuit, the one between the common and normally open contacts. It is, therefore, an electromechanical switch. And when the electrical current is removed from the coil, the spring connected to the armature will return the relay to its initial position.

We've looked at a relay with one normally open and one normally closed contact – these are called SPDT (single pole, double throw) relays, but there are others. An SPST (single pole, single throw) relay only has the normally

open contact, while a DPDT (double pole, double throw) relay has two completely independent sets of common, normally open, and normally closed contacts.

Here, we're going to be concentrating on SPDT relays, which are the most common, and which, of course, can also be used as SPST relays.

### SIMPLE RELAY CIRCUITS

Despite being basic electromagnetic devices, relays can perform most switching tasks. In fact, computers have been made from relays. So, to become familiar with relay circuits, we're going to suggest a couple of things you could try out on a breadboard. We're using a relay with a 5V coil, and

you can buy these for about £5 each. The type we used was part number G2R-1 5DC from Omron. Unfortunately, the pins on relays aren't usually spaced in multiples of 0.1", so you won't be able to plug them into a breadboard directly. Instead, you need to solder some lengths of solid conductor

hook-up wires to each of the pins first.

If you're using batteries as your supply, you'll probably end up with 6V, so put a silicon diode in series with the positive lead of the batteries to drop it to about 5V. Pretty much

any diode will work. Our first circuit (**Figure 2**) couldn't be simpler, so how about building it on a breadboard, omitting the capacitor shown in red?

The box with a diagonal line is the relay coil, although sometimes you'll see it depicted in a way that looks more coil-like. The circuit to the coil passes through the normally closed contact so, when you first apply power, the coil will be energised. This will cause the normally closed contact to open, which will remove the supply from the coil, causing the normally closed circuit to close again. This will continue ad infinitum, so the circuit acts as an oscillator, with the normally open contact being available to drive other components, say an LED, as shown in the diagram. However, there's →

“ When an electrical current is applied to the coil, the electromagnet becomes magnetic ”

”



**HackSpace**

This tutorial is from HackSpace magazine. Each issue includes a huge variety of maker projects inside and outside of the sphere of Raspberry Pi, and also has amazing tutorials. Find out more at [hsmag.cc](http://hsmag.cc).

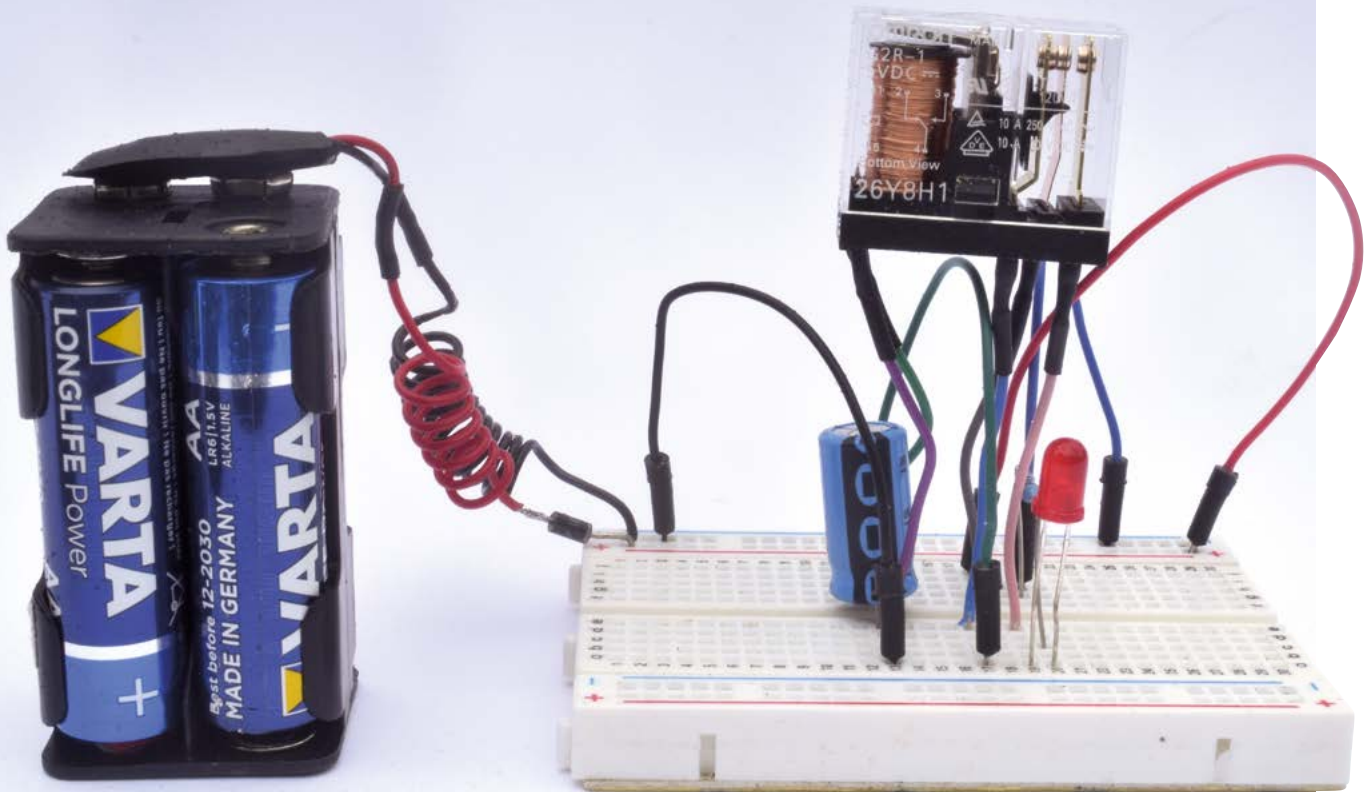

**Above**  Because relays don't have contacts with 0.1" spacing, breadboard circuits aren't going to look too smart, but at least they work

nothing controlling the speed at which the relay turns on and off, other than its mechanical characteristics; the buzzing sound that you'll hear as the contacts open and close suggest a frequency of, perhaps, 100Hz. You can't increase the frequency, although you can reduce it. To do that, wire in the red capacitor, being careful to connect the negative pin on the capacitor (assuming it's an electrolytic capacitor) to the side of the coil connected to negative supply. A value of 1000 $\mu$ F would be a good place to start, but feel free to experiment – the larger the value, the slower it'll be. You should now hear the relay clicking away rather than buzzing, and the LED will turn on and off sufficiently slowly that it won't appear to be continuously lit.

We're not going to describe the workings of our second circuit (**Figure 3**) in detail, because you'll easily be able to figure out how it works. However,

it's an AND gate, which means the LED will be lit only if both push-buttons are pressed at the same time. Since gates like these are some of the most basic building blocks in even complicated digital circuits, the fact that computers have been built from relays might not seem so surprising after all.

### A STEAMPUNK CONTRAPTION

As we'll see later, relays are alive and well today and you might well find them useful in your projects. However, it has to be admitted that they do have a somewhat retro look and feel to them. So, how about making a curious contraption that relies on their quirkiness and wouldn't look amiss adorning your coffee table (though other family members may disagree)? The device and circuit diagram (**Figure 4**) are shown overleaf. It takes our single relay oscillator circuit a bit further, or four relays further to be more



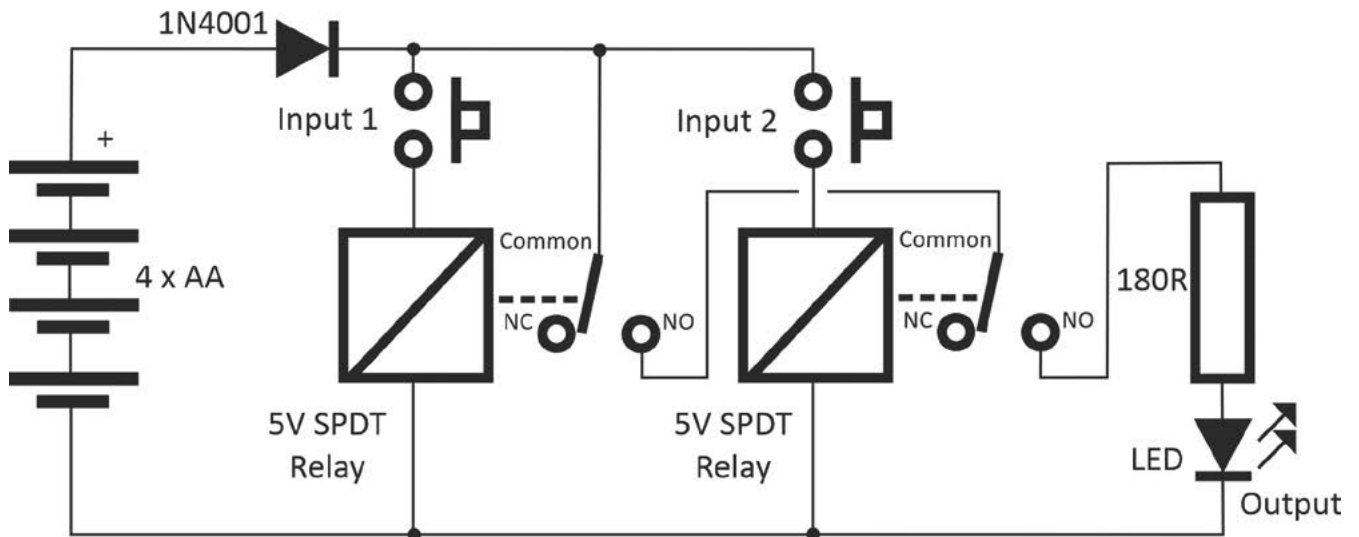

accurate. Because we're aiming for a retro look, we're using tiny MES light bulbs instead of LEDs. You might not be able to find 5V bulbs, but 6V bulbs will be bright enough with a 5V supply.

Understanding how it works is straightforward once it's running, although you might puzzle over what happens when you first turn it on. The answer is that, because of slight differences in the exact values of the capacitors, one of the relays will turn on slightly before any others, and from then on it's plain sailing.

Wiring up the circuit is fairly trivial; making it a work of art, somewhat less so. We chose to give it a steampunk look, so if you follow our lead, you'll be

circuit. If that box is metal, as we recommend, make sure the holes are a lot bigger in diameter than the pins and, to provide further protection against shorts, use heat-shrink tubing to insulate the pins. All you have to do now is fix the relays to the box. You could use epoxy resin, but not if you want to use the relays for something else later, so we used a sticky pad under each relay. Apart from that advice, and recommending you use sockets for the light bulbs, we suggest you peruse the photos and have fun exercising your own creativity. Oh, and with all those relays and old-fashioned light bulbs drawing a high current, batteries might not last too long. So, D cells would be better than AAs (but remember that →

**Figure 3** AND gates made from relays work in much the same way as ones made from transistors, but they're a lot slower

**Below** This relay-based AND gate lights the LED only when both inputs are present. Logic gates are the building blocks of all digital circuitry, so you could make a computer using relays

“

**Solder directly to the pins, and pass the pins through holes in the top surface of the box**

”

spending most of your time and effort in making it look the part. We'll mostly leave that to you, but here are a few things you need to know. We used the type of relay that's mounted on a base with a transparent cover. You can get relays that are totally encased in an opaque box, but since a major part of the appeal of this project is being able to see the relays working, we suggest you do likewise. You can buy sockets for relays, but they cost almost as much as the relays and they don't look at all good, so we suggest you don't use them. Instead, solder directly to the pins, and pass the pins through the top surface of the box in which you're building this

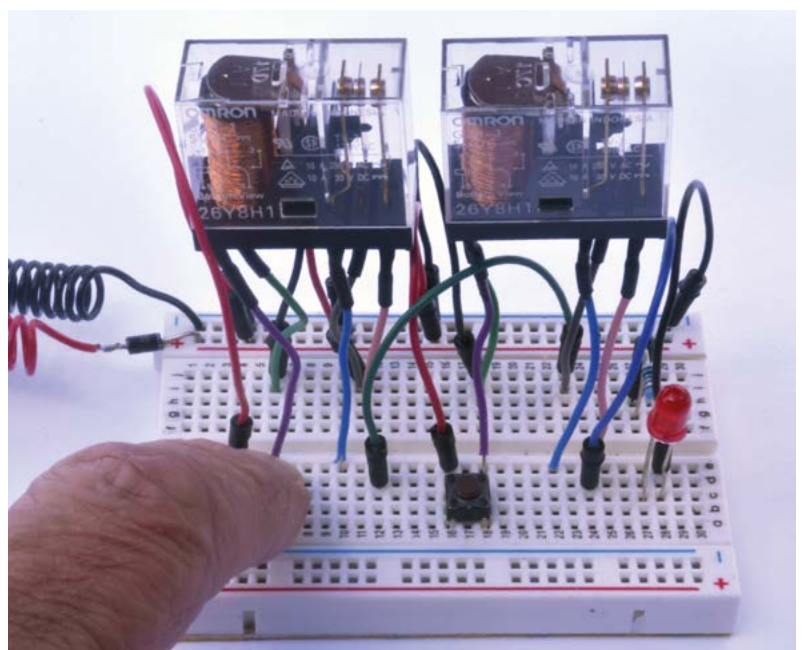

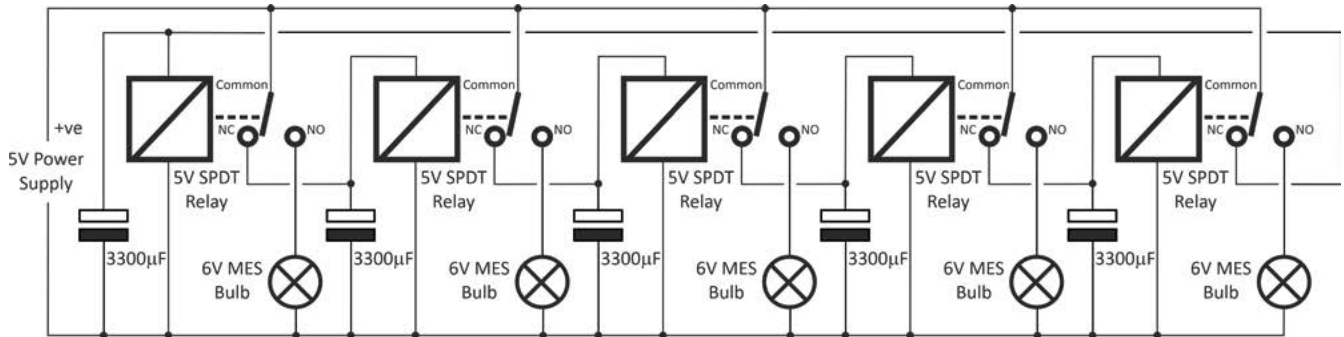

**Figure 4** ♦  
How many lights do you want? Expand the circuit as far as you like

**Below, Right** ♦ ♦  
Here's our steampunk contraption in all its glory, clicks, flashes, and all. In hindsight, though, we have to admit that we missed a trick by not adding gear wheels and the odd watch face

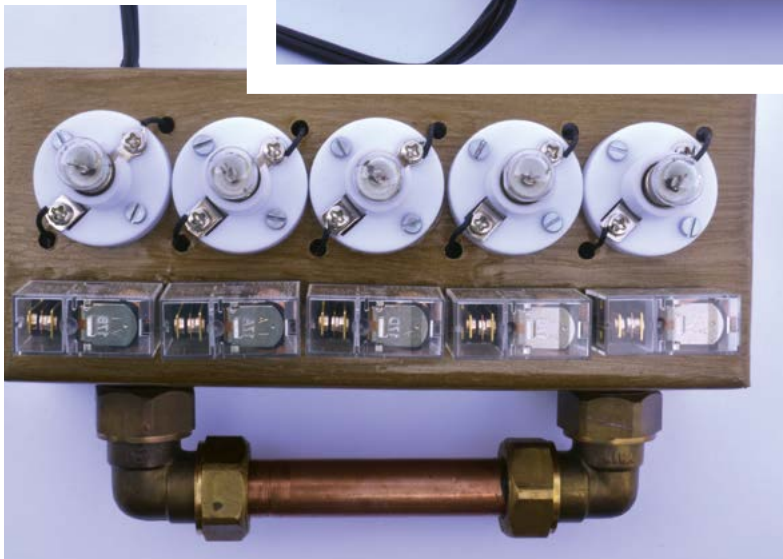
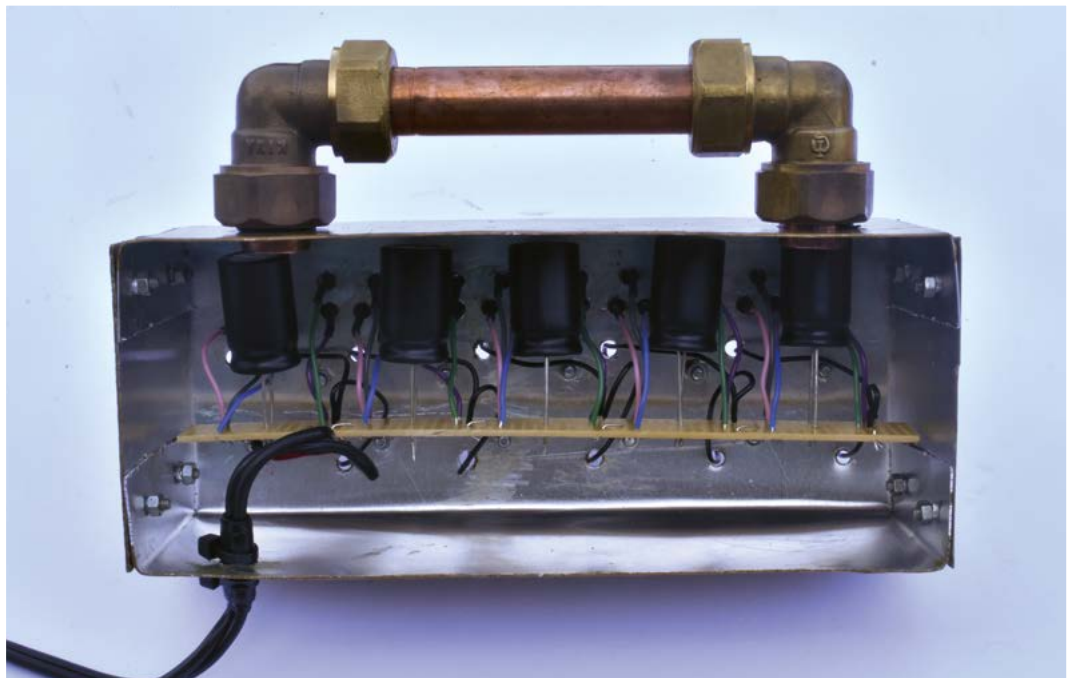

diode we saw earlier to drop the 6V to 5V), although a 5V mains power supply would be better.

### RELAYS TODAY

We haven't taken advantage of this so far, but a feature of relays is that they can switch much higher voltages and currents than the ones used to energise the coil. This is useful in a whole load of applications, of which interfacing to single-board computers (SBCs) is probably one that will be of most interest to HackSpace readers.

If you've dabbled with connecting stuff to SBCs, you'll know that some components like LEDs can be connected directly to GPIO pins, via only a current-limiting resistor, while other components either draw too much current or operate on too high a voltage to

# English not your mother tongue?

The MagPi is also available in German!



Subscribe to the German edition of The MagPi and get a Raspberry Pi Pico with headers and a cool welcome box **FOR FREE!**

Use the coupon code **115PicoDE** on [www.magpi.de/115](http://www.magpi.de/115)



# RETRO GAMING

WITH

# RASPBERRY PI

## 2<sup>ND</sup> EDITION

***Retro Gaming with Raspberry Pi*** shows you how to set up a Raspberry Pi to play classic games. Build your own games console or full-size arcade cabinet, install emulation software and download classic arcade games with our step-by-step guides. Want to make games? Learn how to code your own with Python and Pygame Zero.

- ***Set up Raspberry Pi for retro gaming***
- *Emulate classic computers and consoles*
- ***Learn to code your own retro-style games***
- *Build a console, handheld, and full-size arcade machine*

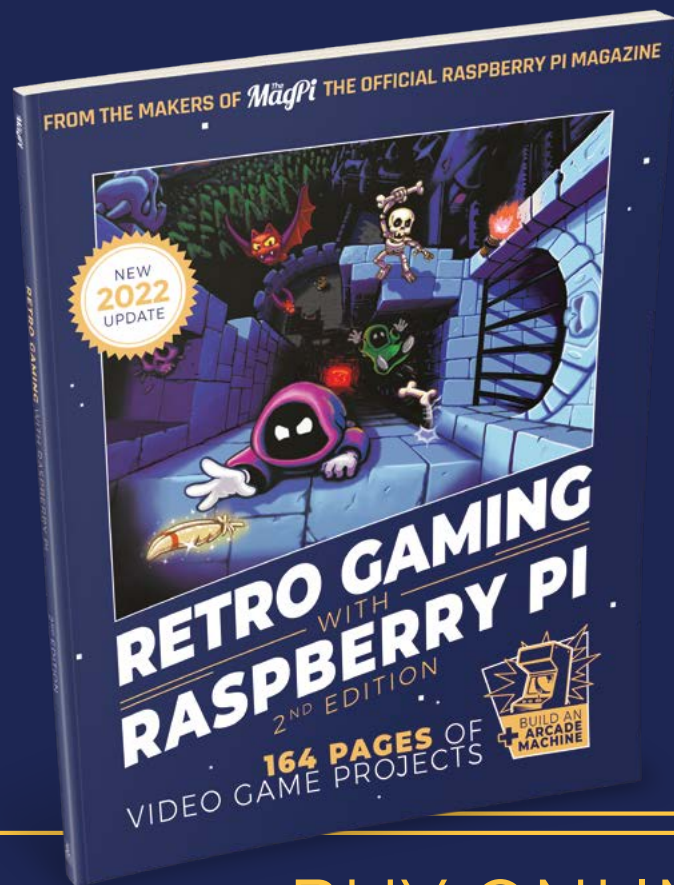

BUY ONLINE:  
[magpi.cc/store](https://magpi.cc/store)

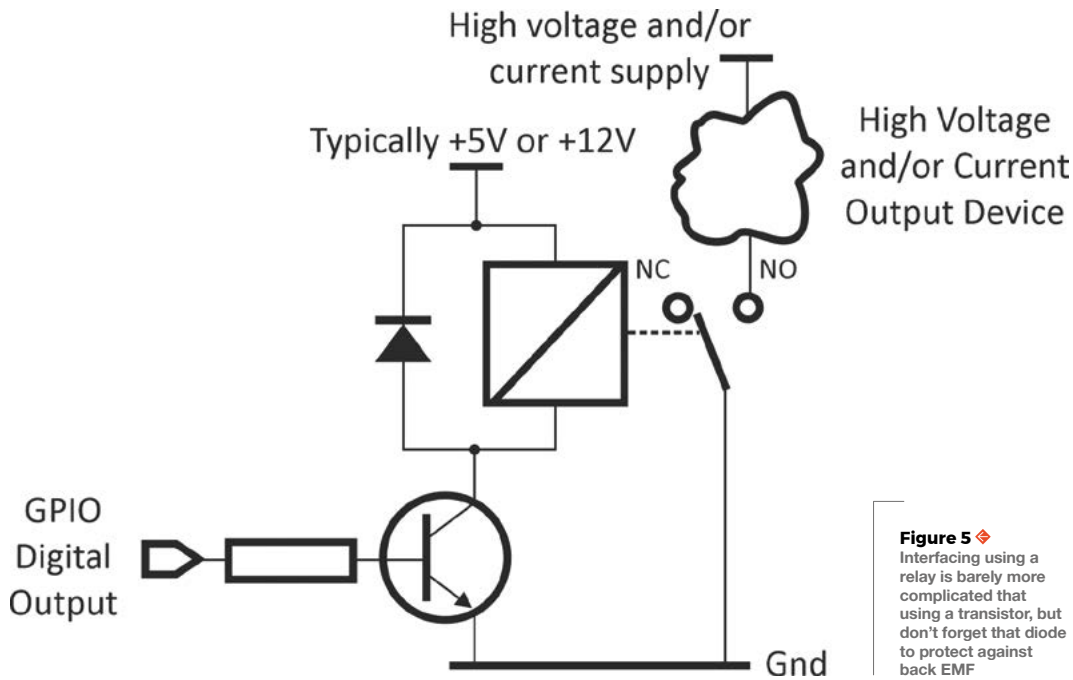

**Figure 5** ♦ Interfacing using a relay is barely more complicated than using a transistor, but don't forget that diode to protect against back EMF

be connected directly. Commonly, a transistor is used in these cases. For these really high-powered devices, perhaps a high-power motor, a relay provides a viable solution. You can buy ready-built relay modules, but here we're going to look at the principles so that you're not always constrained to having to find room in your project box to house these modules.

The basic interfacing circuit is shown in **Figure 5**. As you'll notice, we haven't replaced a transistor with a relay, but added a relay to the transistor. The reason for this is that even the relay coil draws too much current to be powered directly from a GPIO pin. However, we're using the transistor in exactly the same way, as if we were using it to drive a white LED or other device that can't be driven directly. Knowing that, you should be able to figure out exactly how the circuit works, except you might be puzzling about which diode is connected across the relay coil. That's there because of back EMF. In plain English, if you remove a voltage from a coil, it generates a short pulse of current flowing in the opposite direction to the current that formerly flowed. That pulse could be sufficient to burn out the

transistor, so the diode shorts out any such pulses that might occur, but be sure to connect it the right way round. Obviously, any circuit that involves mains voltage is potentially very dangerous. While relays can switch high voltages (check the voltage rating of your relay, as not all can), using a relay doesn't automatically make it safe. Make sure you're familiar with the risks associated with mains voltages before taking on any such circuit. The task is a bit easier if you use a pre-made relay module that mounts a relay (and often a transistor) on a PCB. This doesn't remove all the potential problems, but does mean it's easy to mount safely. If you're not confident with high voltages, there's still plenty of fun to be had with relays at lower voltages.

Who doesn't like electromechanical blinkies? □

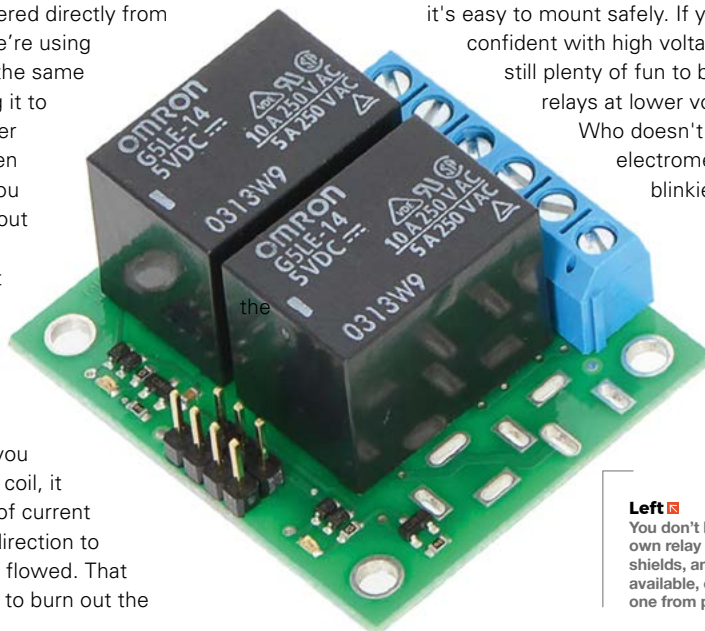

**Left** □ You don't have to build your own relay circuits since HATS, shields, and modules are available, cheaply, like this one from pololu.com

THE *Official*



# RASPBERRY PI HANDBOOK 2023



Create a classic arcade cabinet



Code your own games with Scratch & Python

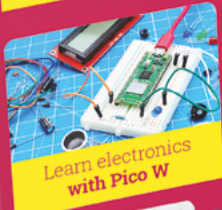

Learn electronics with Pico W



Make & Build with Zero 2 W

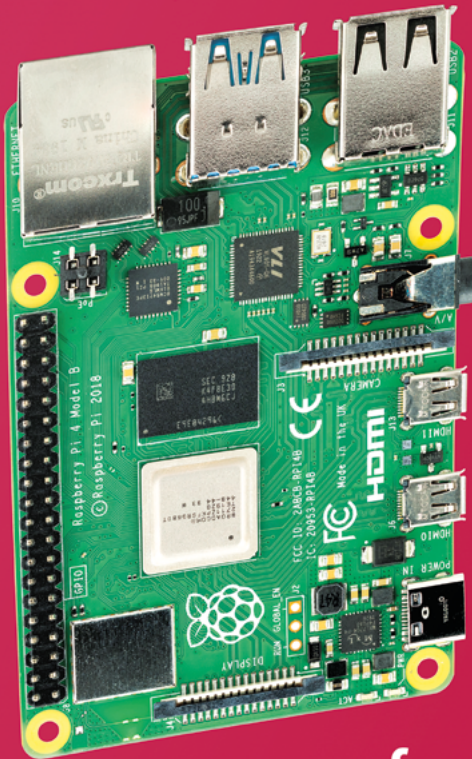

Set up a home network ad-blocker



The best robots you can make!



30 PAGES OF PICO

200 Pages of Inspirational Projects!

FROM THE MAKERS OF *MagPi* THE OFFICIAL RASPBERRY PI MAGAZINE

THE OFFICIAL RASPBERRY PI HANDBOOK 2023

© 2023 Raspberry Pi Foundation

THE *Official*

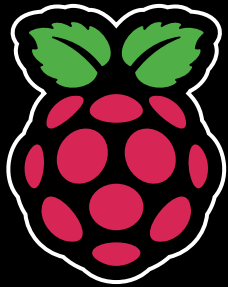

# RASPBERRY PI HANDBOOK

2023



## 200 PAGES OF RASPBERRY PI

- QuickStart guide to setting up your Raspberry Pi computer
- Updated with Raspberry Pi Pico and all the latest kit
- The very best projects built by your Raspberry Pi community
- Discover incredible kit and tutorials for your projects

Buy online: [magpi.cc/store](https://magpi.cc/store)

# Pico-powered Christmas Lights!

Upgrade your Christmas tree with **Rob Zwetsloot** and some smarter lights controlled by Raspberry Pi Pico W

**O**ver the years, we've introduced many ways for folks to make use of Raspberry Pi to power their Christmas decorations – from tree lights, to a star, and even the cover of the magazine as if it were a Christmas card.

This year, it's the turn of Raspberry Pi Pico W, and we think that Pico W is much more suited to the task than a full Raspberry Pi. Using a Raspberry Pi 4 is a bit 'overkill' in our opinion.

There aren't too many parts to this project, so it should be achievable by anyone, and you've got plenty of time before the big day too...

Let's get festive.



# Christmas list

What you'll need for this holly jolly project

## DECORATE YOUR TREE

Install CircuitPython to your Pico W!  
Head here for instructions:  
[magpi.cc/circuitpython](https://magpi.cc/circuitpython)

### 01 Length required

If you have some lights for your Christmas tree already, you should be able to learn from them how big a strip of NeoPixels you'll need to cover the tree. Otherwise, get out a tape measure and start calculating!

### You'll Need

- ▶ A Raspberry Pi Pico W
- ▶ A Christmas tree (real or fake)
- ▶ A reel of NeoPixel LEDs (such as [magpi.cc/npledstrip](https://magpi.cc/npledstrip))
- ▶ Prototyping wire
- ▶ Push-button (optional)
- ▶ Breadboard (optional)

### 02 Wrap it around

Once you have your NeoPixel strip, wrap it around the tree, starting from the bottom branches. We'll connect to the strip from the bottom, so make sure it also starts at the rear of the tree so it won't be so noticeable. Make sure you know how many LEDs are on your tree for later.

### 03 Baubles, tinsel, and more

Now, you can add the rest of your decorations without creating havoc to your lights or vice versa. We like a nice star on the top, like from *The MagPi* 64 ([magpi.cc/64](https://magpi.cc/64)).



# Setting up your lights

Some basic ways to really make your tree special

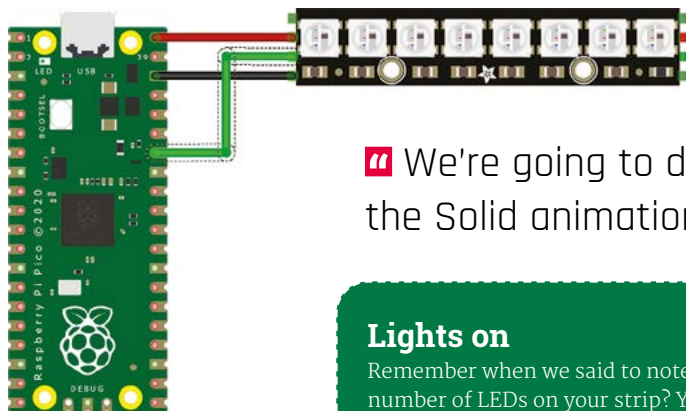

▲ Here's how to wire up your NeoPixel lights to Pico

“ We're going to do the Solid animation ”

## Lights on

Remember when we said to note down the number of LEDs on your strip? You'll need it here. There are a couple of ways to make NeoPixels light up in a steady colour, but to make things easier down the road, we're going to do the Solid animation – which isn't really an animation at all, but it's from the same Adafruit LED Animation library.

We use RGB values to turn them all white, in this case (255, 255, 255), and we're plugging the data wire into pin 34, aka GP28 in the code. We've also set it to be 100 LEDs, so change that if you need to. They're also set to 75% of maximum brightness.

[lights\\_on.py](#)

## More patterns

There are other animation patterns you can try with CircuitPython, including Blink, which turns the LEDs on and off at a regular interval; Chase, which is a bit similar to Comet but has blocks of lit LEDs follow each other; and even a Rainbow animation that cycles through every colour.



### Spiralling lights

We can create a cool effect where the LEDs seem to climb and twirl up the tree by using the Comet animation type. The leading light will be brightest, with the 'tail' getting progressively dimmer.

We're going to have it run up the length of the tree so that no light is ever truly off. However, by changing the `tail_length` variable, you can make it work differently. We're also using white again as our colour.

`spiral.py`

**DOWNLOAD  
ALL THE CODE:**

 [magpi.cc/xmaspico](https://magpi.cc/xmaspico)



### RGB colours

RGB is a way of creating colours using values of red, green, and blue (hence RGB) with numbers from 0 to 255. Using a mixture of them will create different colours, as shown in the table. The best way to find a colour combination is to Google the name followed by RGB.

Red	Green	Blue
255	0	0
0	255	0
0	0	255
255	0	255
190	194	203
255	140	0

### Colour changing

We're using RGB lights so, with a little extra coding, we can have them change colours. In this example, we'll have every other LED alternate between red and green, classic Christmas colours, using ColorCycle.

You could also set them to just switch the entire strip between two colours using two Solid animations with a time delay between them being animated. We've created variables that hold the red and green colours in RGB to make the code a little easier to follow too.

`colour_change.py`

### Glowing lights

For `lights_on.py`, we used the Solid animation to make it easier to understand how the other animations will work – and also will allow them to more easily work together.

For our glowing method, we'll use the Pulse animation. This slowly fades the lights out and then back on – you can even set the speed of how it fades as well. The `speed` variable sets how long it is between each step of the fading process, so higher is slower.

`glowing.py`

### Button-activated

With a button connected to Pico, you could easily have your lights cycle between the different animations with some tweaks to the code. For how to add a button to a project like this, refer to *The MagPi* #122 and the Poltergust G-00 tutorial.



# Smart light projects

Pico W projects that make full use of NeoPixels that just need a little festive hacking

## POV display

### Animated light illusions

We've talked about this previously in *The MagPi*; this project works by spinning a stick of LEDs very fast and lighting them up in specific sequences to give an illusion of a persistent image. It's not too dissimilar to how CRT TVs work, and just makes use of how quickly human eyes can process things.

Either way, this is a very cool thing that you could modify with specific Christmas images, or even as an advent calendar or countdown for Christmas on your tree. So, to not have it spinning for a few weeks straight, you could make it motion-activated or remote-controlled.

[magpi.cc/picopov](http://magpi.cc/picopov)





## Raspberry Pi Beret

### Remote-controllable NeoPixels on a hat

Despite its name, this project (which you can read more about on page 32) uses a Pico W as a web server and light controller. The creator had it set up so that he could control the lights on his beret for indicating in a busy convention centre, so people would know where he was going. It's all controlled via a browser on his phone as well. With some tweaks to the colours and the functions of the lights, it could very easily be used for Christmas tree lights – with Chase and Blink part of his code, and glowing/pulsing easy to do using an iterative 'for' loop.

[magpi.cc/picoberet](https://magpi.cc/picoberet)

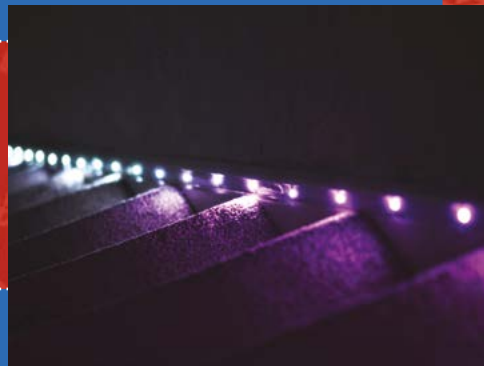

## Pico stair lights

### Light-activated LEDs

Whereas we like to keep indoor Christmas trees on during the day, it's better for outdoor lights to be on during the night. You could easily set a time for the plug, but where's the fun in that? These stair lights use an LDR (light dependent resistor or photoresistor) so that they switch on when the hallway is dark enough.

The same process can be used for when it gets dark outside – or even reversed so that, when it gets light in your house, the tree turns on. Just switch the colours to be more to your festive liking, and you're good to go with only one extra little component.

[magpi.cc/picostairlights](https://magpi.cc/picostairlights)

## OTHER FESTIVE PICO PROJECTS

### Festive PCBs

Ben Everard, the editor of our sibling publication, HackSpace Magazine, custom-made this PCB with LEDs and resistors in specific places to give a decorated tree appearance.

[hsmag.cc/issue50](https://hsmag.cc/issue50)



### Snapology tree topper

Another style of tree topper, this uses paper origami to create a unique-looking sphere that is both lightweight and shines out a very interesting pattern. It's sure to be the topic of many conversations with guests.

[magpi.cc/snapology](https://magpi.cc/snapology)



### DIY Christmas Fireplace

This neat-looking desktop decoration uses a load of PCBs to create a 3D-looking fireplace, with a Pico driving the LED matrix to replicate the flickering flames of a fire.

[magpi.cc/picofireplace](https://magpi.cc/picofireplace)



# Petoi Robot Dog **Bittle**

## SPECS

### DIMENSIONS:

200 × 110 ×  
110 mm (7.9 × 4.3  
× 4.3 inch)

### CONTROLLER:

NyBoard V1;  
ATmega328P  
CPU; 6-axis  
MPU6050; 16  
PWM channels,  
4 × Grove  
channels; 7  
× RGB LED  
(NeoPixel);  
Serial UART,  
I2C, infrared,  
buzzer;  
Bluetooth and  
WiFi dongles

### SERVO AND POWER:

9 × 8.4V P1S  
servos (10 in  
pack); 7.4V  
1000mAh  
Li-ion battery  
pack, 1-hour  
function, 2-hour  
charge time

► Petoi ► [petoi.com](http://petoi.com) ► £299 / \$299

Build your own miniature Spot-like robot dog.

## Lucy Hattersley takes Petoi for walkies

**L**ike most tech fans, we're in awe of Boston Dynamics' Spot robot. You don't have to look far to see Petoi Bittle's inspiration, and it looks like a miniature Spot that you build and program yourself. An idea that is sizzling with promise.

Billed as a "palm-sized, open-source bionic robot dog," Petoi Bittle is a cute and versatile robot designed for lifelike animal behaviours. We've tested countless robots, but few are as personable, or frankly likeable, as Petoi Bittle.

The kit contains a plastic body chassis, a rechargeable 7.4V Lithium-ion battery, ten PS1 servo motors (nine are used in the build and one is included as a spare), and the NyBoard motor controller. Three dongles are included for connection: Bluetooth, WiFi, and infrared, and an

infrared remote control that runs pre-programmed movements (walk, dance, lie-down, and so on).

### Build process

We received two kits for testing. One required assembly (the fun part) and another was fully assembled, with a Raspberry Pi 3 Model A+ attached. A detailed build manual is available at [bittle.petoi.com](http://bittle.petoi.com), with more information available at [magpi.cc/bittleonlinehelp](http://magpi.cc/bittleonlinehelp).

The assembly process is detailed in the twelve-page online manual. Each step requires a high level of precision, especially with the wiring, positioning, and calibration of the nine servo motors. The calibration process involves attaching an adapter to the NyBoard mid-build, and connecting to a desktop or mobile app (or



► Bittle is a fantastic little robot that can walk, sit, and dance around

Arduino IDE). We opted for the USB adapter, and used the Peto App ([magpi.cc/petoigit](http://magpi.cc/petoigit)) for Windows PC to perform the calibration. There is also a Mac app available, but disappointingly no Linux app.

After the build process, we needed to recalibrate the legs, which involved removing them and reinserting them while rotating the teeth. Calibration is an important, and time-consuming, step in the build (see [magpi.cc/jointcalibrator](http://magpi.cc/jointcalibrator) for more information).

We enjoyed the build process tremendously, but please note that this is a detailed build with many steps, and many opportunities to get things wrong. This 30-minute YouTube build video is another good source of information ([magpi.cc/makebittleyt](http://magpi.cc/makebittleyt)).

## Let's go for walkies

Once the robot is built, you can quickly take it through some moves using the infrared remote control. This runs Bittle through a range of walking, standing, and performance routines. While this is certainly enough fun, we are more interested in programming our dog with its own moves. The first step for us was investigating the Skill Composer in the Peto Desktop app. Here, you can access the preset postures and see the settings used for each servo motor to attain that position. Moving each slider enables you to adjust each shoulder, arm, and knee joint value, as well as pan the head.

Beyond that, the OpenCat framework is going to be used to program Bittle. Here, the documentation passes you on to the OpenCat forum for more information ([magpi.cc/opencatcode](http://magpi.cc/opencatcode)). The coding documentation is a work in progress, and spending



▲ Raspberry Pi OS and ROS (Robot Operating System) promise programming capabilities

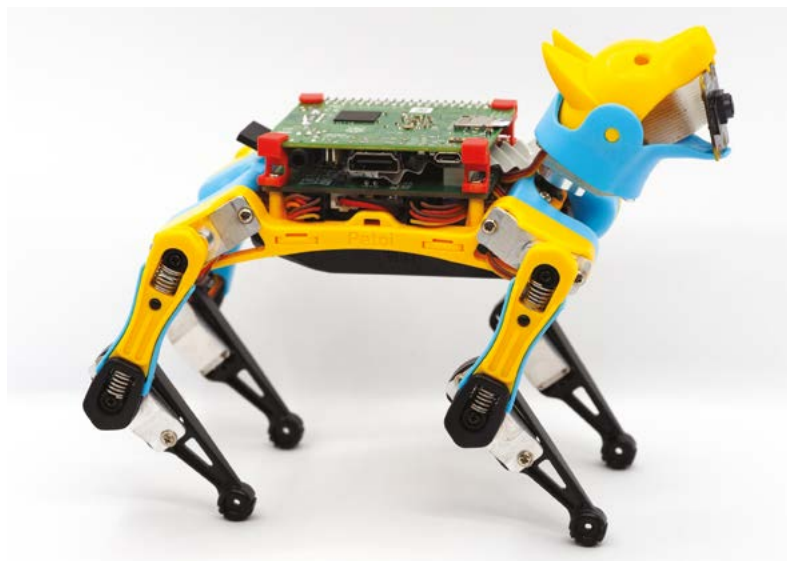

time on the forums is a good way to get to know more about Bittle.

## Raspberry Pi integration

A switch on the NyBoard enables you to move away from the default Arduino and towards Raspberry Pi. You will need to solder a small  $2 \times 5$  header onto NyBoard to plug in a Raspberry Pi 3 Model A+.

## “Recreating Boston Dynamics' Spot is a tricky business”

Raspberry Pi OS needs a custom configuration that can be found at [magpi.cc/bittlepiserial](http://magpi.cc/bittlepiserial). After setup, you are recommended to use an ROS (Robot Operating System) wrapper inside Docker. There are a bunch of examples for using ROS with Raspberry Pi and Bittle, but little in the way of API and documentation.

The finished robot itself is a wonderful thing and an absolute delight to play with. However, we found many things about the build tricky, from the assembly to calibration and controlling the individual components. This is not a robot for the faint of heart. The build documentation is great, but it petered out for us too quickly after the setup process. Hopefully, more documentation regarding Raspberry Pi and ROS is in the works.

It turns out that recreating Boston Dynamics' Spot is a tricky business, even in miniature toy form. If you are prepared to put in the legwork, we think Bittle is the perfect robot pet. Peto informs us you can buy it directly from its site, or via its Amazon store ([magpi.cc/bittleamazon](http://magpi.cc/bittleamazon)). 

▲ A fully assembled Bittle robot uses nine servo motors to control its four legs and rotate the head

## Verdict

Bittle is an absolutely fantastic robot, but do be prepared for a tricky build process. The end result is a robotic pet that is packed with personality. It's well worth the required effort.

**9**/10

# MicroPi Starter Kit

## SPECS

### SENSORS:

Ultrasonic distance sensor, line sensor

### MOTOR:

2 x servos for wheels

### CHASSIS:

Metal construction

► MicroPi ► [micropi.org](http://micropi.org) ► £200 / \$219

A new way of using MicroPi means a new robot you can program. **Rob Zwetsloot** takes a look

**W**e reviewed the first iteration of MicroPi a while back in the magazine – it’s a package that uses a Raspberry Pi 3A+, a special HAT on top, and some custom code to try and turn Raspberry Pi into a learning machine right out of the box. We thought it did pretty well in that regard, but MicroPi is back with upgraded kits and lessons that offer a wide range of coding learning.

What makes this new version special is the inclusion of a robot kit that MicroPi can be installed onto it. While you could do a lot with the original MicroPi, the robot kit adds a whole host of new functions to play and grow with.

The kit is quite simple to put together, with very little construction required and plain instructions on how to get to that point too, thanks to an included booklet.

## Class in session

One of the unique things about the MicroPi kits is that there’s a full course of lessons, complete with video, available for free. Following the QR code or link on the instructions ([micropi.org](http://micropi.org)), you can sign up for the course that uses the teach:able framework to streamline the process and give you a completion progress.

While the instruction book does have the information on how to do the initial set up, you can also start at the online course with that before diving into the different example programs and explanations of the different things you can program on the completed kit.

MicroPi uses its own Python library to help aid in the programming, and some of the example codes are only really a few lines long – similar to GPIO Zero in some ways.

The code is not explained in the text, but instead in the video – although the code listings are there to copy and paste, or just read for reference if you need them. The creator tells us these lessons are still being tested and worked on, so these examples are likely to improve.

## Build quality

One thing we want to mention as well is that while a lot of beginner robot kits, even ones as expensive as this one, can have a flimsy chassis or parts,

▼ The free online courses feature some great example code you can build into more advanced projects

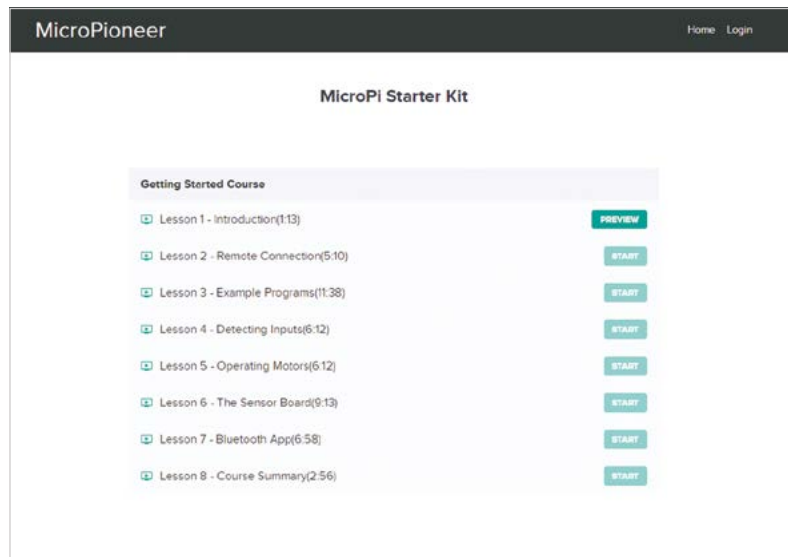



the robot you can build with this is quite sturdy. The frame is metal and the caster wheel feels a lot higher quality than other robots we've tested in the past.

That price is perhaps the biggest thing that stands out with this kit, taking it a little out of the range of many as a beginner kit. It does come with a lot though – the full MicroPi in the add-on and Raspberry Pi combo, along with a robot with a lot of programming and customisation opportunities.

“ One of the unique things about the MicroPi kits is that there's a full course of lessons ”

There is a bulk classroom bundle though, which is where something like this will probably really shine. **M**

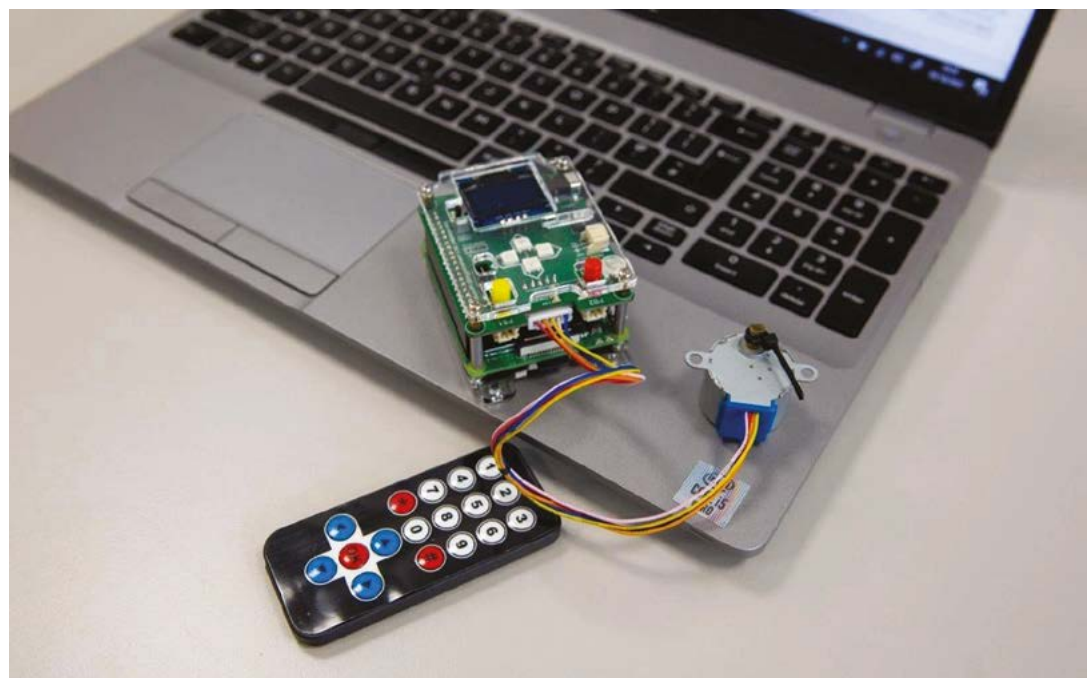

▲ The full kit comes with MicroPi – a Raspberry Pi 3A+ with a purpose-built HAT – and a robot kit

◀ MicroPi is easy to program with, being set up to be headless out of the box

## Verdict

A little expensive but a very complete package that offers a large number of functions for people to learn to code with.

# 10/10

# 10 Amazing: Pico accessories

Do more with your Pico and Pico W with these excellent add-ons

**Y**ou can do a ton of things with a Pico – just looking over this issue, and the last few issues, of *The MagPi* boggles the mind with what it can accomplish. To get the most out of it though, you'll need to accessorize, so here's a small selection of some of the cool things you can add to Pico. [M](#)



## ▲ 1.8" LCD display

### Tiny display

There are a few options for adding a display to Pico, and this one is fairly cool as it's barely bigger than the footprint of Pico itself.

[magpi.cc/picolcd](http://magpi.cc/picolcd) | £11 / \$12

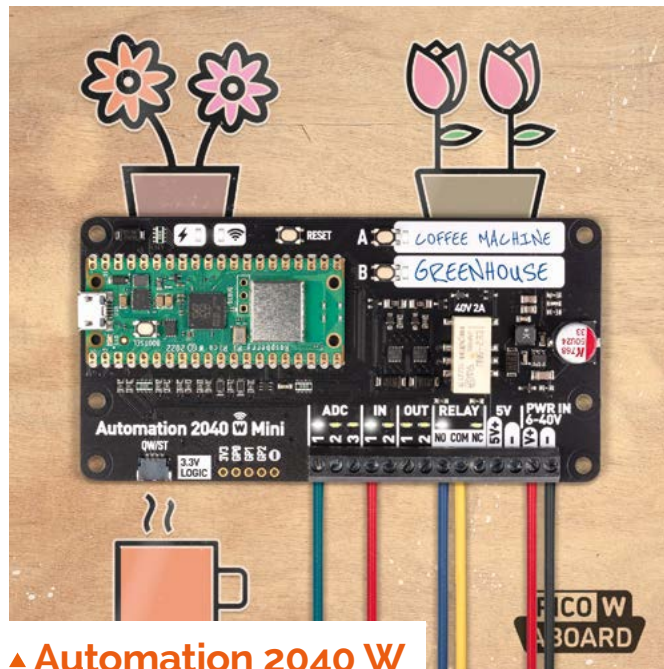

## ▲ Automation 2040 W

### Automate everything

Powerful enough for industry and easy enough to use for your home projects, this automation board really does do it all.

[magpi.cc/auto2040w](http://magpi.cc/auto2040w) | £59 / \$58

## ▼ Robotics Board

### Automaton control

Turn Pico into the brains of your very own robot. This board can control four motors and eight servos, along with 27 I/O expansion points.

[magpi.cc/picorobotboard](http://magpi.cc/picorobotboard)  
£17 / \$19

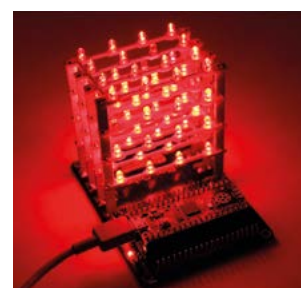

## ▲ Pico Cube

### Fancy LEDs

This 3D array of 64 LEDs can be used to create very cool-looking light displays – whether you plan on using one colour, or creating a weird and wild animation.

[magpi.cc/picocube](http://magpi.cc/picocube)  
£18 / \$20



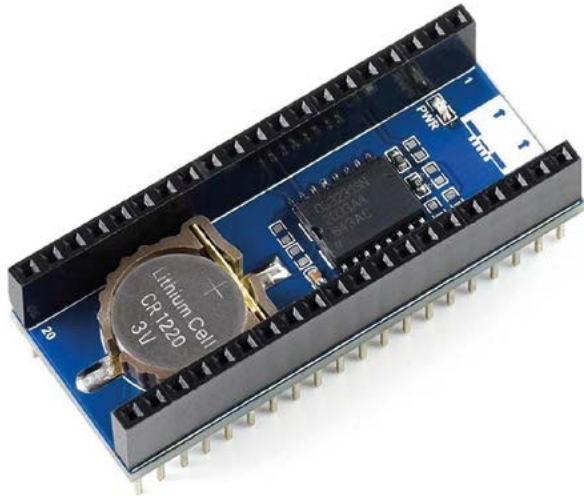

## ▲ Precision RTC Module

### Tell the time

If you want to keep exact time on your Pico project and don't have access to the internet regularly, this RTC will keep the clock ticking.

[magpi.cc/picortc](http://magpi.cc/picortc) | £16 / \$18

## ► Pico Explorer Base

### Experiment with Pico

Described as an 'electronic adventure playground', this board includes a little breadboard and screen so that you play around with your Pico to your heart's content.

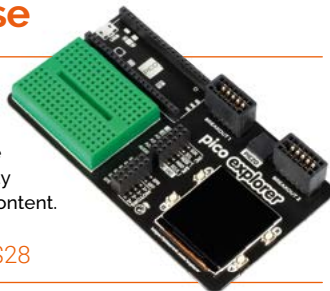

[magpi.cc/picoexplorer](http://magpi.cc/picoexplorer) | £25 / \$28



## ▲ Pico Inky Pack

### E-ink display

This tiny e-ink display might not be in full colour, but it does look very cool when running the right kind of images. It's also barely bigger than Pico itself.

[magpi.cc/inkypack](http://magpi.cc/inkypack) | £15 / \$17

## ► Pico Audio Pack

### Line out

Add high-quality stereo sound to your Pico – it can handle audio after all! With loads of features for audiophiles, this is aural heaven.

[magpi.cc/audiopack](http://magpi.cc/audiopack) | £15 / \$17

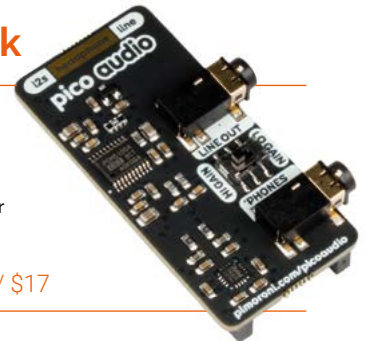

## ▲ RetroVGA

### Classic Pico computing

We featured this in *The MagPi* 122's retro gaming feature – it's a very cool board that allows you to add serial joysticks, connect to VGA monitors, and more.

[magpi.cc/retrovga](http://magpi.cc/retrovga) | £9 / \$10

## ► Pico RGB Keypad Base

### Auxiliary keys

It's surprisingly easy to program a Pico to act as an auxiliary keyboard, whether to use for macros or hot keys in your favourite game. This version even has light-up LED keys.

[magpi.cc/picokeypad](http://magpi.cc/picokeypad) | £22 / \$24



# Learn Raspberry Pi OS

Resources to make the most of Raspberry Pi's official operating system. By **Phil King**

## Raspberry Pi Help

AUTHOR

Raspberry Pi Foundation

Price: Free

[magpi.cc/rpihelp](http://magpi.cc/rpihelp)

While Raspberry Pi computers can run a wide range of operating systems (see our feature in *The MagPi* #111, [magpi.cc/111](http://magpi.cc/111)), the official Raspberry Pi OS is the most popular choice. Based on Debian Linux, it's an easy-to-use operating system with the default option of a desktop interface (though you can install a Lite version without one).

Raspberry Pi's Help online hub is a great place for newcomers

to learn how to get started with their Raspberry Pi, including guides on how to set it up and use add-on hardware. Most importantly, there's a guide to using Raspberry Pi OS.

For starters, you'll discover how to navigate the desktop, alter keyboard and mouse settings, and connect to the

internet. While there will be some programs and tools preloaded, you'll learn how to install extra software and update the operating system. It also covers Raspberry Pi Configuration options and using Terminal commands. **EM**

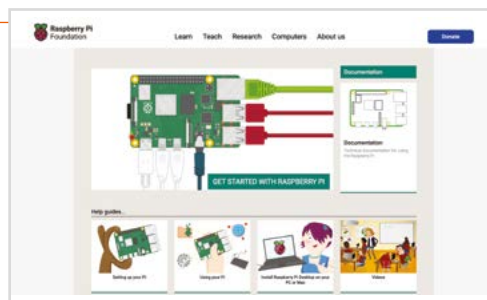

## Bookmark these

Learn more about the OS from these websites



### RASPBERRY PI DOCUMENTATION

The official online documentation includes a long section on Raspberry Pi OS, which covers updating the OS, installing software with APT, playing audio and video, and a lot more.

► [magpi.cc/docs](http://magpi.cc/docs)

### DEBIAN REFERENCE

Raspberry Pi OS is based on Debian Linux, so this thorough reference guide should come in handy.

You can even install it from the Terminal with `sudo apt install debian-reference`.

► [magpi.cc/debianref](http://magpi.cc/debianref)

### RASPBERRY PI FORUMS

The official forums are a great place to learn from other users and obtain technical help. They include a Raspberry Pi OS topic for all things related to the operating system.

► [magpi.cc/rpiosforum](http://magpi.cc/rpiosforum)

# The Official Raspberry Pi Beginner's Guide

AUTHOR

**Gareth Halfacree**

Price:  
£10 (Free PDF)

[magpi.cc/bguide4](http://magpi.cc/bguide4)

Some Raspberry Pi computer bundles include this 252-page official guide book and it's a great way to get started and learn all about your new computer. Of particular interest here is the 'Using your Raspberry Pi' chapter, which starts by showing how to use Raspberry Pi OS's Welcome Wizard to select various options, including connecting to your wireless router. It then covers navigating the desktop to access programs and tools, using the built-in Chromium web browser and File Manager, and

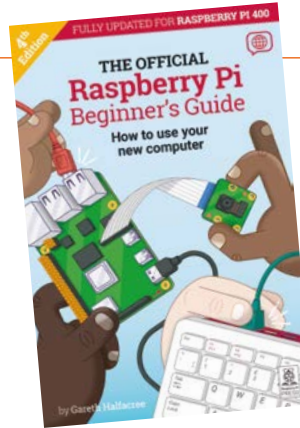

making use of the excellent LibreOffice productivity suite – this includes applications for word processing, spreadsheets, databases, presentations, and formulas.

Once you're familiar with the operating system, the rest of the book helps you to make the most of your Raspberry Pi by learning to program and connect electronic circuits. 

## Recommended reading

Books to read to explore the OS

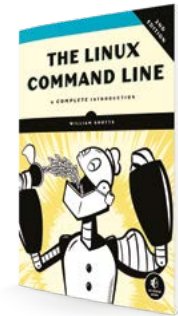

### THE LINUX COMMAND LINE

As well as using Raspberry Pi OS's desktop GUI, you can input a host of useful and powerful Linux commands in the Terminal. This 500+ page tome tells you all you need to know to become a power user.

► [magpi.cc/linuxclbook](http://magpi.cc/linuxclbook)

# Working From Home

AUTHOR

**Alasdair Allan**

Price:  
Free

[magpi.cc/workfromhome](http://magpi.cc/workfromhome)

As well as being brilliant for programming and digital-making projects, Raspberry Pi 4 and 400 computers are powerful enough to be used as replacement desktop

computers for people working from home. It's a topic covered in detail in this official blog post by Raspberry Pi's head of documentation, Alasdair Allan.

As he shows, it's fairly simple to set up email and VPN clients, while the LibreOffice productivity suite is a good alternative to Microsoft Office – although you can access the online version of the latter in the Chromium web browser, as well as your Google Drive and associated apps.

For video conferencing, you can connect a camera, plug in some headphones or speakers, and add a USB microphone. Many popular platforms can be used, such as Zoom, Hangouts, and Skype. 

### LIBREOFFICE GETTING STARTED GUIDE

This official guidebook (also available as a free PDF download) from the makers explores the fully-fledged office suite – included in Raspberry Pi OS – in detail to help you get the most out of it.

► [magpi.cc/librebooks](http://magpi.cc/librebooks)

### LEARN TO CODE BY SOLVING PROBLEMS

The Thonny IDE in Raspberry Pi OS lets you write Python programs. Learn more about the language (and coding in general) with this excellent book, suitable for complete beginners.

► [magpi.cc/zingaropython](http://magpi.cc/zingaropython)

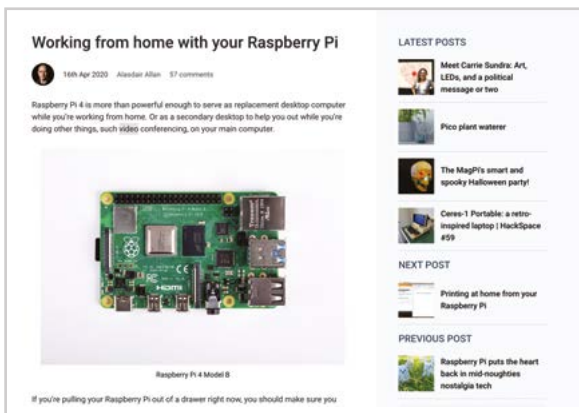



# Sophy Wong

We talk to a multi-disciplinary designer who specialises in wearable tech and digital fabrication for creative expression

- > Name **Sophy Wong** | > Occupation **Artist-in-residence**
- > Community role **Maker** | > URL **sophywong.com**

One of the coolest people on the wearable side of the maker community is Sophy Wong – she’s so cool that we have a book all about her wearable tech ([magpi.cc/wearablebook](http://magpi.cc/wearablebook)). You’ll often find her at cons showing off her amazing cosplays and 3D-printed fabric. However, it wasn’t until college for graphic design that she started making.

“The great thing about design is that it’s a framework that can be applied to any kind of making,” Sophy explains. “So, being interested in lots of different mediums and techniques, I took as many art electives as I could squeeze into my schedule. I took printmaking, ceramics, photography, drawing, sculpture, video media.

After graduating and becoming a professional graphic designer, I continued to dabble with sewing and fashion design, and eventually started my own small business designing and making clothing. From there, I moved on to costuming, working at Seattle Opera in the costume department. Along the way, I discovered DIY electronics and wearable technology projects, and I began combining all my interests together to design and build costumes and fashion projects that use technology like LEDs in artistic and expressive ways.”

## What was your first Raspberry Pi project?

The first Raspberry Pi project I worked on was the SelfieBot, which was a collaboration with my husband Kim Pimmel, who is also a maker and designer. We wanted to build something special for our local Seattle Mini Maker Faire, and we thought it would be fun to create our take on a selfie booth. So we used a Raspberry Pi with a camera and thermal printer for the selfies, and added a screen with custom animations for facial expressions. We recorded my voice for giggles and cute robot sounds, and



> Sophy’s original character, NULL, makes use of several bits of wearable tech and is inspired by sci-fi and VR



◀ Sophy has been featured many times in our sibling publication, HackSpace magazine

timed them with the animated face graphics to give SelfieBot a personality. The result is a little character that makes taking a selfie at an event into a fun, interactive experience.

#### What inspires you?

Inspiration is something that I actively search for and catalogue,

printing on fabric, and creating full garments and accessories with the technique. It's a bit experimental and I love designing for such a new medium. I'm also a huge fan of spacesuits, real and imaginary, and making my own spacesuit was a long-time dream of mine. My custom-designed fantasy

One day, I'd love to make a full ensemble for someone to wear to the Met Gala! [M](#)

“ I love thinking about the future and imagining things that don't exist yet ”

so I always have ideas for things I want to make. I get inspiration from movies, books, music, art museums, or even just products on display in a store. I'm very drawn to science-fiction and fantasy, because I love thinking about the future and imagining things that don't exist yet. I don't like to sit around and wait for inspiration to find me, I like to hunt for it myself!

#### What are your favourite projects you've made?

Lately, I have been really enjoying working with 3D

spacesuit is definitely one of my favourite projects. I'm currently working on a new spacesuit to be used in a short film, and I'm super-excited to finish it and see it used to tell a cool sci-fi story!

#### Any dream projects you'd like to make?

I'd love to continue making costumes and fashion pieces to be used in films and music videos, as I've had the opportunity to design and build costumes for two music videos and it's just amazing to be able to tell stories through my work.



▲ This temperature-sensitive skirt changes its colours depending on the surroundings

# MagPi Monday

Amazing projects direct from our Twitter!

**E**very Monday we ask the question: have you made something with a Raspberry Pi over the weekend? Every Monday, our followers send us amazing photos and videos of the things they've made.

Here's a selection of some of the awesome things we got sent this month – and remember to follow along at the hashtag #MagPiMonday! 📷

01. Akkie is great at making very small projects that can be very useful
02. Get your spooky projects ready as Halloween is just around the corner...
03. Now this is a car computer upgrade we can get behind
04. We love the very DIY look of this plant keeper system – looks like it was built by Borrowers
05. An interesting way of monitoring and automating energy use
06. BurgerBot is now a BurgerTurtle. Can it draw a line for itself to follow?
07. With a partner or trusted friend, this could be a very cute way to communicate
08. We love seeing cool transport timetable displays – they're definitely a must-do project
09. This spinning robot is going places
10. The pi-top 4 robot is a cool project for learning
11. Do not confuse cat food cans for tomato cans
12. A good way to know what's on your Bluetooth speaker without digging out your phone

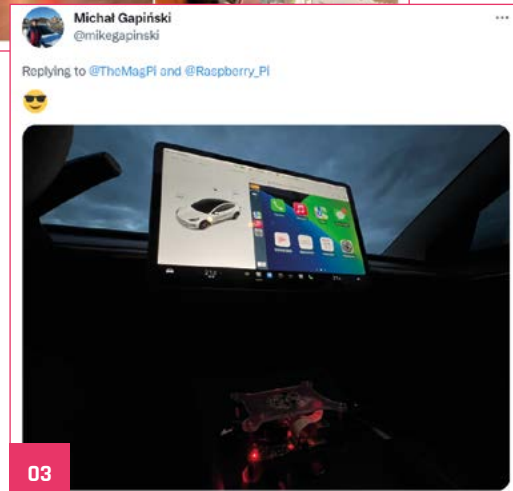



**Andrew Lewis** @LewisWorkshop  
 Replying to @TheMagPi

I finished off this last week - pi pico powered plant moisture and temperature monitor. The scales tip to show wet/dry soil, and the thermometer arrow moves to show temperature. #MagPiMonday



04

**Crypto Panse** @CryptoPanse - Sep 26  
 Replying to @TheMagPi

What about a home energy management system (hems)? I use my Pi pico to read my electricity consumption and my produced energy.  
 If produced energy > consumption the led turns red and heating in my office is activated.



05

**Kevin McAleer** @kevsmac  
 Replying to @TheMagPi

Happy #MagPiMonday - this weekend, I upgraded BurgerBot so that it can now draw and be wirelessly controlled via an access point mode it hosts itself. Catch the video here: [youtu.be/CYP3oL3Vs9o](https://youtu.be/CYP3oL3Vs9o)  
 #micropython #robot #picow #raspberrypi #robotics #STEM #robots #circuitpython



06

**Tiretdu\_6** @tiretdu\_6  
 Replying to @TheMagPi

Built an e-ink frame with @pimoroni Inky Developer and a Pi Zero, that any friend can send pictures or draw into, through a homemade webapp on a dedicated URL



07

**tim\_yates** @tim\_yates  
 Replying to @TheMagPi

Still working on my Pico based @MCRMetroInk tram departure board



08

**DIY\_Electronics** @finexofficial - Oct 7  
 Replying to @TheMagPi

little autonomous rover to drive around the house from scratch @arduino and @Raspberry\_Pi controllers [reddit.com/r/arduino/comm...](https://reddit.com/r/arduino/comm...)

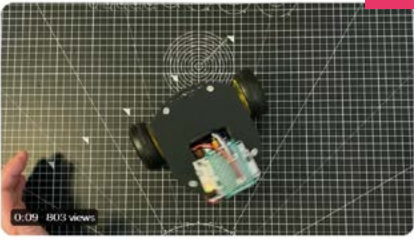

09

**Richard K** @RichardKirbyRPI  
 Replying to @TheMagPi

I am working on connecting a Pi to a kitchen scale via a HX711 so I can measure portions and keep track of calories consumed. Portion control is working for my cats, so should work for me too.

Tomato cans are for calibration. Cat is rounder then he should be.



11

**Pierre-yves Baloché** @FunkyPiwy  
 Replying to @TheMagPi

It was building time this weekend with the #Alex project from @getpitop around the #pitop4 robotic components. Had great family time while easily assembling the unit, prior to some upcoming coding. #MagPiMonday



10

**AxWax** (@axwax@fosstodon.org) @AxWax  
 Replying to @TheMagPi

Good evening!

For this #MagPiMonday I had fun displaying what I'm currently listening to on my newly acquired @pimoroni Inky Developer E Ink screen on the @Raspberry\_Pi.



12



# Shadowboard build

Get stuff cut perfectly with this shadowboard

**W**e got a cool email from a reader Scott, who made a light box with a Raspberry Pi Camera inside that captures the outline/shadow of objects in the light box. This image can then be sent to a CAD device to drill wood or foam so that the item fits perfectly inside it. Scott uses it in his video ([youtu.be/Wcxh1LLtAE](https://youtu.be/Wcxh1LLtAE)) to help organise his tools in his toolbox, but you could also use it to keep your miniatures safe, or do the movie thing where you have something locked safely in a padded briefcase. [M](#)



▲ The internals of the light box with the camera situated at the top



- ▲ Raspberry Pi uses a little bit of machine learning to help create the silhouette of the item
- ▶ The resulting image can be used to create a shape in CAD software

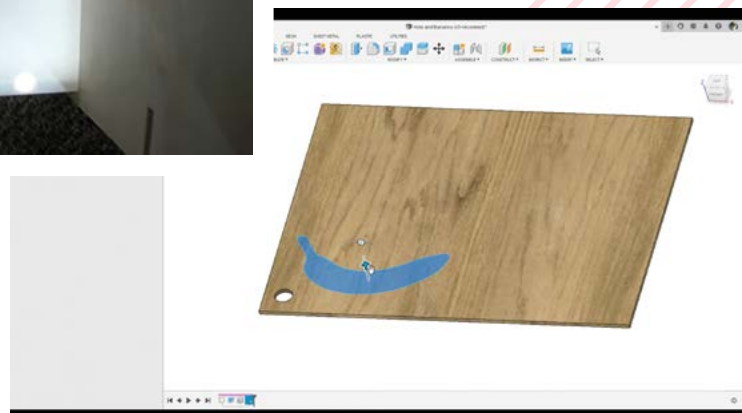

Crowdfund **this!** Raspberry Pi projects you can crowdfund this month

5-in-1  
5GHz Video  
Streaming  
Transmitter

## AURGA Viewer

This USB dongle can turn several devices into a wireless streaming device, including Raspberry Pi, at up to 1080p and with decent audio to boot. It also works with graphic tablets and such, making it a unique way to add touchscreens to Raspberry Pi.

► [kck.st/3L93a0B](https://kck.st/3L93a0B)

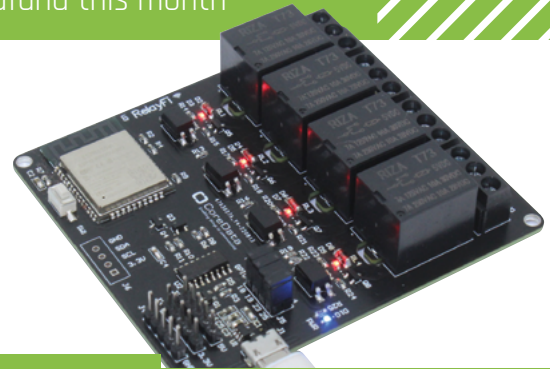

## RelayFi

This WiFi-enabled relay board can connect to Raspberry Pi or Pico to help expand your home automation network. "RelayFi is a 4-channel smart relay board powered by ESP32-WROOM that has the ability to safely control up to four appliances or devices on a load of 110-250 VAC/7A, 30 VDC/10A, and photo-coupling isolation Optocoupler for safety."

► [kck.st/3dVjGFj](https://kck.st/3dVjGFj)

## Explore E-ink technology with **EPDK** from **PERVASIVEDISPLAYS** **E-paper display (EPD) Pico Development Kit**

The EPD Pico Development Kit from Pervasive Displays includes everything to start exploring E-ink technology.

- ⇒ EPD Extension board Gen 3 (EXT3-1) board
- ⇒ Raspberry Pi Pico RP2040 (with pin header)
- ⇒ 2.66" E-ink Monochrome Display with Fast Update
- ⇒ 20-pins and 2-pins bridging cable
- ⇒ Pin mapping label (3 pieces)

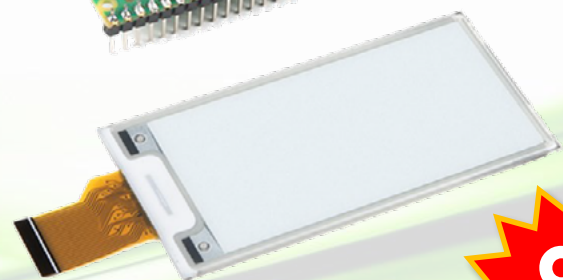
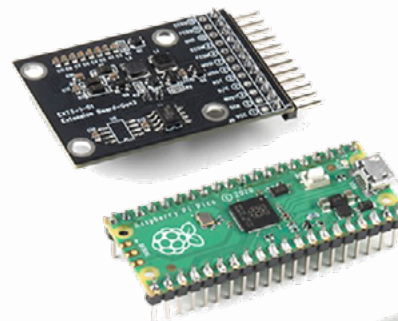

Grab a USB cable, download the library and start exploring E-ink technology today!

Learn more **PERVASIVEDISPLAYS**  
[www.pervasivedisplays.com](http://www.pervasivedisplays.com)



Buy it **sparkfun**  
ELECTRONICS  
[www.sparkfun.com/products/19219](http://www.sparkfun.com/products/19219)



# Your Letters

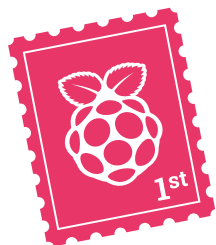

## Image request

I'm interested in using one of the images found on your website in one of our educational modules, and I am writing to ask if this would be possible.

What is the process of gaining permission for an image such as this?

Sandra via email

The MagPi is licensed under Creative Commons, specifically CC BY-NC-SA 3.0 ([magpi.cc/creativecommons](http://magpi.cc/creativecommons)), so this is absolutely possible – this goes for all the editorial content included in *The MagPi*! This is one of the reasons why we release all our issues as a free PDF.



Attribution-NonCommercial-ShareAlike  
3.0 Unported (CC BY-NC-SA 3.0)

▲ The license details are pretty simple, but make sure to check the exact details

## Contact us!

- Twitter [@TheMagPi](https://twitter.com/TheMagPi)
- Facebook [magpi.cc/facebook](https://magpi.cc/facebook)
- Email [magpi@raspberrypi.com](mailto:magpi@raspberrypi.com)
- Online [forums.raspberrypi.com](https://forums.raspberrypi.com)

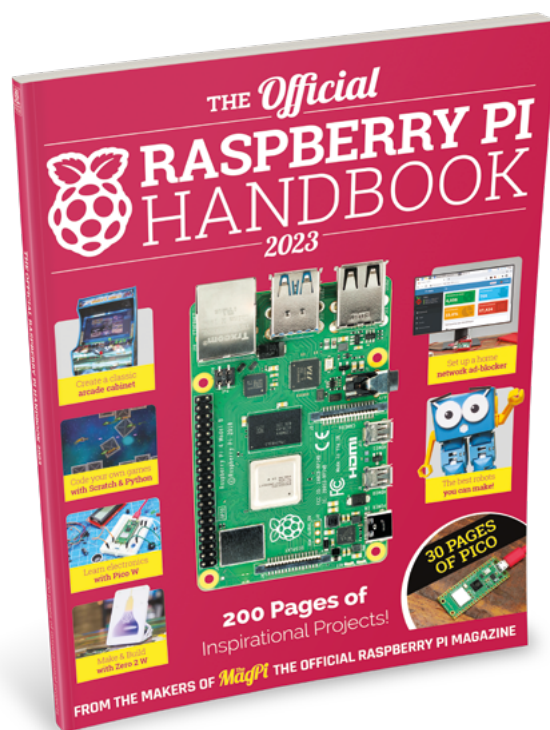

▲ We make sure only the best of the best gets into our Official Project Handbook

## Year choice

Why is this the Project Handbook 2023? Last I checked we were still in 2022. Will this book still be relevant in 2023?

Fanoush via blog

Annuals like this are traditionally given the year they're released for – this is our handbook for 2023! It's just a quirk of publishing. It's the same reason this November issue is technically out in October.

The content in the handbook includes tutorials, projects, and info that will still be true and relevant throughout 2023 – whether you need inspiration or something to build!

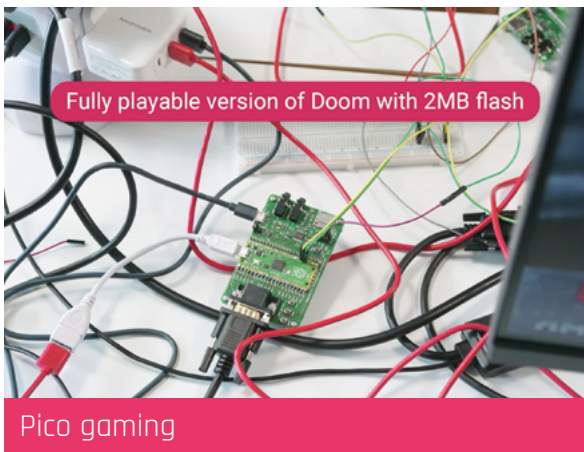

I read issue 122 with great interest – Raspberry Pi Pico, used for games? I assumed you meant toys like Simon or the like, but to see that Pico is even powerful enough to run full computer games came as quite a shock! Thank you for illuminating this new avenue for development and play.

**Nico** via email

Raspberry Pi Pico manages to surprise us more and more! The ability to run games like on PicoSystem, or just run DOOM in general is very impressive. Compared to computers of yore that were the first to play games, it's actually a lot more powerful – and it even has two cores.

We'll keep an eye out for any other cool Pico gaming content for the future.

# 3 ISSUES FOR £10



 **Subscribe by phone:**  
**01293 312193**

 **Subscribe online:**  
**[magpi.cc/subscribe](https://magpi.cc/subscribe)**

 **Email:** [magpi@subscriptionhelpline.co.uk](mailto:magpi@subscriptionhelpline.co.uk)

Subscribe for £10 is a UK-only offer. The subscription will renew at £30 every six months unless cancelled. Free Pico W included with a 12-month subscription in USA, Europe and Rest of World. This is a limited offer. Not included with renewals. Offer subject to change or withdrawal at any time.

# Your FREE guide to making a smart TV

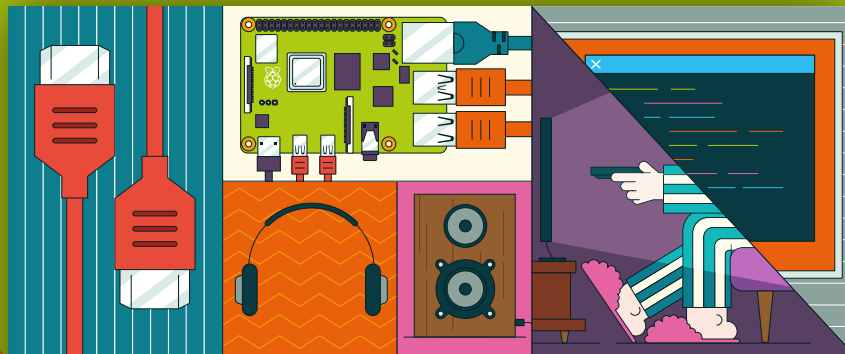

## BUILD A RASPBERRY PI MEDIA PLAYER

Power up your TV and music system

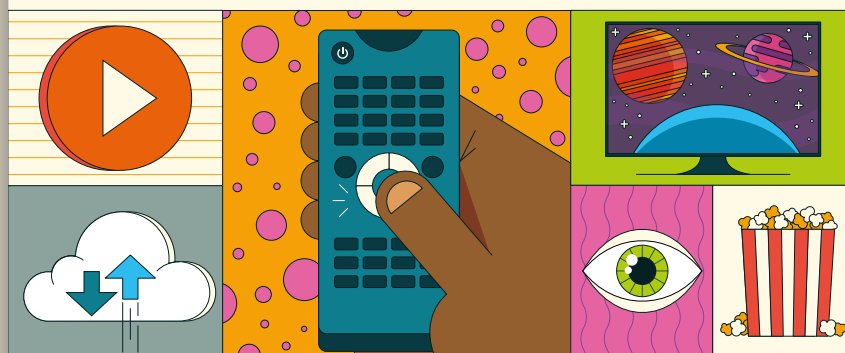

FROM THE MAKERS OF *MagPi* THE OFFICIAL RASPBERRY PI MAGAZINE

[magpi.cc/mediaplayer](http://magpi.cc/mediaplayer)

# WIN 1 OF 5

# TUFTY 2040s

A gorgeous colour LCD screen that is much like a full colour version of the excellent Badger 2040 E-ink badge. We reviewed it in issue 122 and gave it a 9/10 due to how crisp the screen was, and how versatile it was to program too.



Head here to enter: [magpi.cc/win](https://magpi.cc/win) | Learn more: [magpi.cc/tufty2040](https://magpi.cc/tufty2040)

## Terms & Conditions

Competition opens on **26 October 2022** and closes on **24 November 2022**. Prize is offered to participants worldwide aged 13 or over, except employees of Raspberry Pi Ltd, the prize supplier, their families, or friends. Winners will be notified by email no more than 30 days after the competition closes. By entering the competition, the winner consents to any publicity generated from the competition, in print and online. Participants agree to receive occasional newsletters from The MagPi magazine. We don't like spam: participants' details will remain strictly confidential and won't be shared with third parties. Prizes are non-negotiable and no cash alternative will be offered. Winners will be contacted by email to arrange delivery. Any winners who have not responded 60 days after the initial email is sent will have their prize revoked. This promotion is in no way sponsored, endorsed or administered by, or associated with, Instagram, Facebook, Twitter or any other companies used to promote the service.

# HELP! MY COMPUTER IS BROKEN

## (How do I fix it?)

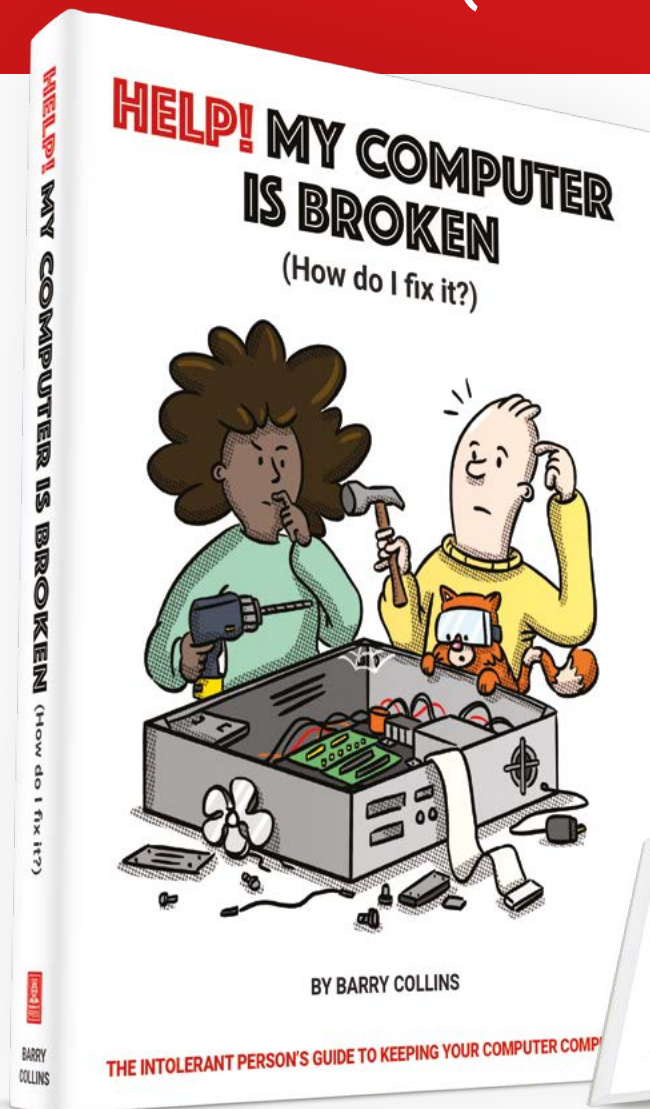

**Help! My Computer Is Broken** takes the most common computer problems and tells you how to fix them. It's as simple as that! If you've ever wondered why your laptop won't turn on, you can't get a WiFi connection, your printer isn't printing, or why everything is so slow – well, this is your book...



BUY ONLINE: [magpi.cc/helpbook](http://magpi.cc/helpbook)



# RASPBERRY PI PRESENT PLANNER

WHAT TO PUT UNDER YOUR TREE  
THIS HOLIDAY SEASON



## Plus!

A rad Gamma Spectrometer

Create a tiny CNC machine

Set up a maker room

DON'T MISS OUT!  
[magpi.cc/subscribe](http://magpi.cc/subscribe)

[@TheMagPi](https://twitter.com/TheMagPi)

[fb.com/MagPiMagazine](https://facebook.com/MagPiMagazine)

[magpi@raspberrypi.com](mailto:magpi@raspberrypi.com)

## EDITORIAL

### Editor

Lucy Hattersley  
[lucy@raspberrypi.com](mailto:lucy@raspberrypi.com)

### Features Editor

Rob Zwetsloot  
[rob@raspberrypi.com](mailto:rob@raspberrypi.com)

### Sub Editor

Nicola King

## ADVERTISING

Charlotte Milligan  
[charlotte.milligan@raspberrypi.com](mailto:charlotte.milligan@raspberrypi.com)  
+44 (0)7725 368887

## DESIGN

[criticalmedia.co.uk](http://criticalmedia.co.uk)

### Head of Design

Lee Allen

### Designers

Olivia Mitchell, Sam Ribbits

### Illustrator

Sam Alder

## CONTRIBUTORS

Mike Bedford, David Crookes,  
PJ Evans, Rosemary Hattersley,  
Nicola King, Phil King,  
KG Orphanides

## PUBLISHING

### Publishing Director

Russell Barnes  
[russell@raspberrypi.com](mailto:russell@raspberrypi.com)

### Director of Communications

Liz Upton

### CEO

Eben Upton

## DISTRIBUTION

Seymour Distribution Ltd  
2 East Poultry Ave,  
London EC1A 9PT  
+44 (0)207 429 4000

## SUBSCRIPTIONS

Unit 6 The Enterprise Centre  
Kelvin Lane, Manor Royal,  
Crawley, West Sussex, RH10 9PE  
+44 (0)1293 312193  
[magpi.cc/subscribe](http://magpi.cc/subscribe)  
[magpi@subscriptionhelpline.co.uk](mailto:magpi@subscriptionhelpline.co.uk)



This magazine is printed on paper sourced from sustainable forests and the printer operates an environmental management system which has been assessed as conforming to ISO 14001.

The MagPi magazine is published by Raspberry Pi Ltd, Maurice Wilkes Building, St. John's Innovation Park, Cowley Road, Cambridge, CB4 0DS. The publisher, editor, and contributors accept no responsibility in respect of any omissions or errors relating to goods, products, or services referred to or advertised in the magazine. Except where otherwise noted, content in this magazine is licensed under

a Creative Commons Attribution-NonCommercial-ShareAlike 3.0 Unported (CC BY-NC-SA 3.0).  
ISSN: 2051-9982.





# Without borders

Wherever you go, people are using Raspberry Pi says **Rob Zwetsloot**

**A**s I write this, **Maker Faire Rome has just concluded, and it was yet another event that the team from Raspberry Pi attended to show off Raspberry Pi Pico and what you can make with it.**

Apparently tens of thousands of people visited the event, and reports back from the team claimed “every single one of them visited the booth.” They were probably exaggerating though.

While we haven’t run an event calendar in *The MagPi* for a while now, this, and other recent tech events and online interactions, have reminded me just how much Raspberry Pi tech is used around the world, and how differently it can be used as well.

## Cultural differences

As you may know, American English and British English have some differences. Not only in terms of just outright different words, but also in how they’re used – Matt Richardson, Community Engagement Manager at Raspberry Pi, informs us that, for robots that are remote-controlled and not autonomous, it’s much more

proper to call them rovers in the US. Which makes sense!

While visiting Maker Faire Tokyo a few years back, the style of projects on display was very different than those in the UK or US. Here, folks’ creativity was on show, with weird and wonderful robots and contraptions

“It would be cool to see people here experiment with more artistic projects just for the fun of it”

that wouldn’t look out of place in a Rube Goldberg machine. In comparison, Westerners seemed to be making stuff with practicality and usefulness in mind.

Neither way is better, however it would be cool to see people here experiment with more artistic projects just for the fun of it.

## Global community

Through the (questionable) magic of social media, we’ve managed to stay connected to international makers over the last few years, hearing about robot competitions in Puerto Rico, coding classrooms, seeing mini laptops from Hong Kong, and Astro Pi entries from all over the world.

We love to showcase projects from readers and the wider community here in *The MagPi*, so never feel like you can’t send something our way! Even if English isn’t your first language, we can make something look (and read) great if you’ve got a cool build to show off.

Hopefully, as we get to more events throughout the world, and more events run in general, we’ll be able to meet more of you and get your excellent projects in the magazine – wherever you are. 

AUTHOR

**Rob Zwetsloot**

Rob is currently trying to find more ways to use a Pico to create Christmas decorations, much to the chagrin of his flatmate

[magpi.cc](http://magpi.cc)

HiPi.io

# HIGHPI PRO

•———— The new case from the HiPi.io team ————•



- Rapid tool-free assembly and disassembly
- Large internal volume for HATs
- Compatible with Pi 2/3/4
- Multiple lid options
- Passive & Active Cooling options
- Secure microSD card cover
- VESA mount support
- Molding-configurable output ports customizable for volume orders
- Printed logo for your branding

Available at these great Pi stores:



Contact your favorite Pi store if it's not listed here

# PiKVM

Manage your servers or workstations remotely

A **cost-effective** solution for data-centers, IT departments or remote machines!



**PiKVM HAT**  
for DIY and custom projects



**Pre-Assembled version**

- Real-time clock with rechargeable super capacitor
- OLED Display
- Bootable virtual CD-ROM & flash drive
- Serial console
- Open-source API & integration
- Open-source software

Available at the main Raspberry Pi resellers



Reseller suggestions and inquiries:  
**wholesale@hipi.io**